

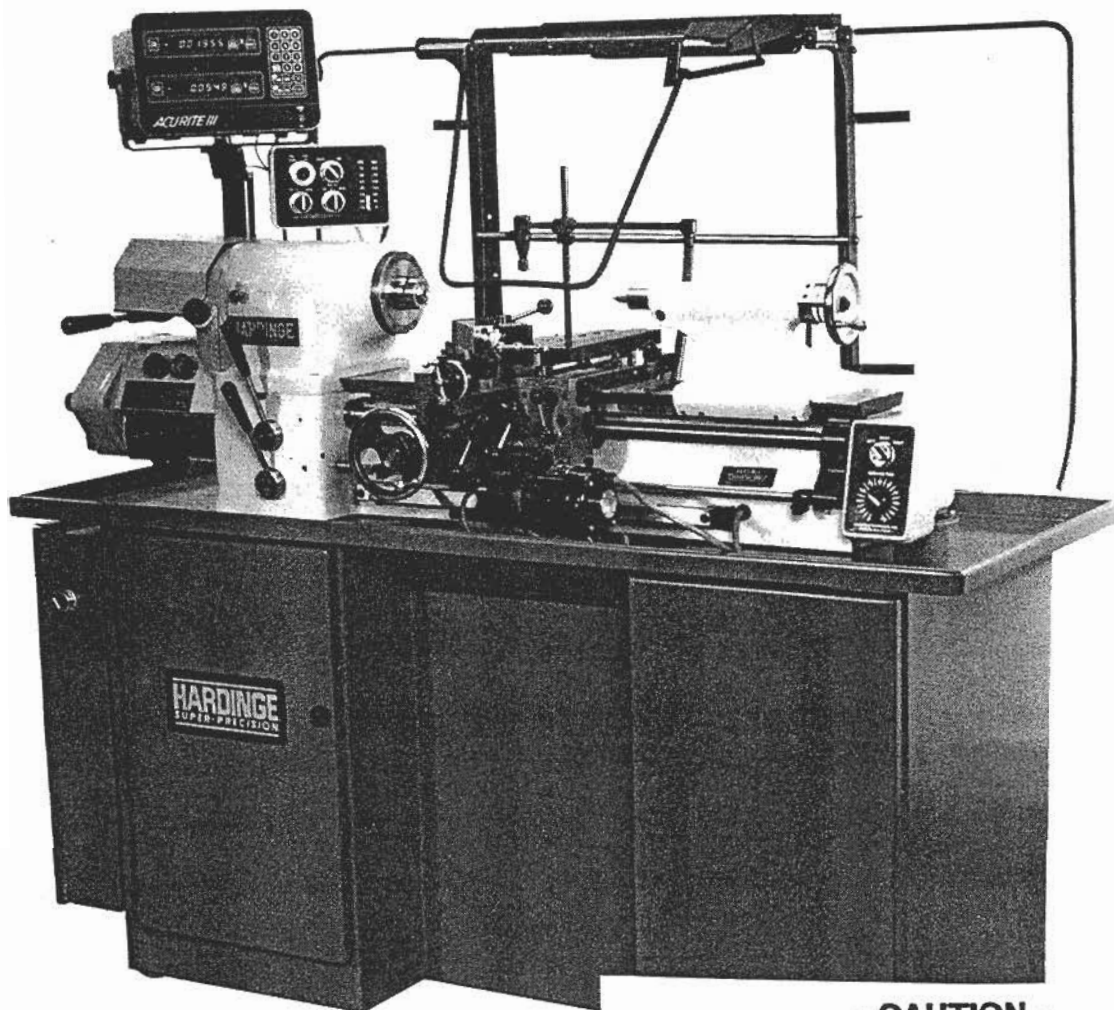

OPERATOR'S MANUAL



HLV-DR Model Shown

- CAUTION -

Use petroleum based cutting fluids only. If water based coolants are used, the machine warranty will be voided. 02/19/93

**HARDINGE HIGH-SPEED SUPER-PRECISION®
HLV® TOOLROOM and TFB®-H PRODUCTION LATHES**

**READ COMPLETE INSTRUCTIONS CAREFULLY
BEFORE OPERATING MACHINE**

When this instruction book was printed, the information given was current. However, since we are constantly improving the design of our machine tools, it is possible that the illustrations and descriptions may vary from the machine you received. This means that the machine you received is the latest improved model to better fulfill your requirements.

HARDINGE SAFETY RECOMMENDATIONS

Your Hardinge machine is designed and built for maximum ease and safety of operation.

However, some previously accepted shop practices may not reflect current safety practices and procedures, and should be re-examined to insure compliance with the current safety and health standards.

We recommend that all shop supervisors, maintenance personnel, machine and tool operators be advised of the importance of safe maintenance, setup and operation of Hardinge-built equipment. Our recommendations are described below:

- DO** be sure equipment is properly grounded.
- DO** disconnect main electrical power before attempting repair or maintenance.
- DO** wear appropriate eye and foot protection and when necessary, respirator, helmet, gloves, and ear muffs or plugs.
- DO** be sure proper guarding is in place and all doors closed and secured.
- DO** keep chemical and flammable material away from electrical or operating equipment.
- DO** provide a safe, clean, work area free of slippery surfaces.
- DO** read appropriate manual or instructions before attempting operation or maintenance of a machine.
- DON'T** leave machine unattended while it is operating.
- DON'T** exceed the rated capacity of a machine.
- DON'T** operate equipment unless proper maintenance has been regularly performed and the equipment is known to be in good working order.
- DON'T** operate any equipment if unusual or excessive noise or vibration occurs.
- DON'T** operate any equipment while any part of the body is in the proximity of potentially hazardous areas.
- DON'T** use any toxic or flammable substance as a solvent cleaner, or coolant.
- DON'T** allow the operation or repair of equipment by untrained personnel.
- DON'T** check finishes or dimensions of workpiece near running spindles.
- DON'T** clean machine with air hose.
- DON'T** operate any machine with rings, watches, jewelry, loose clothing, ties, or long hair which is not contained by net or shop cap.

FOR YOUR OWN PROTECTION — WORK SAFELY

HARDINGE BROTHERS, INC.
Elmira, New York 14902

© Hardinge Brothers, Inc. 1978

CONTENTS

	Page
Carriage and Compound Slide	6
Cleaning Machine	2
Collet Closer	8, 9
Coolant Facilities	4
Electrical Connections	3
Floor Plan	16
Foundation, Machine	2
Power Feed	6
Installation, Machine	2
Leveling Machine	2
Lubrication	8
Regular Equipment	13
Serial Number	5
Specifications	13
Spindle, Brake	5
Changing Speed	5
Driving Unit	4
Free	5
Lock Pin	5
Taper Nose Tooling, To Apply	9
Tailstock	5
Tooling	12
Tooling Dimensions	16
Thread Charts	14, 15
Thread Cutting	10, 11

LUBRICANTS

(Use Recommended Product or Equivalent)

Product	Vendor
Spindle Oil (Velocite #6)	Mobil Oil Corporation
Cosmolube #2	Houghton, E. F. and Company
Molyube (Anti-seize)	Bel Ray Company, Inc.
Vactra Oil No. 2	Mobil Oil Corporation
Automatic Transmission Fluid Mobilfluid 350	Mobil Oil Corporation
Kling Grease	Magnus Chemical

INSTALLATION

DO NOT REMOVE MACHINE FROM SKID before moving machine to the location where it is to be used.

Remove crating. Remove four bolts which hold machine to the shipping skid. There are two bolts at the extreme left-hand end inside pedestal and two at the right-hand end.

The machine may be removed from the skid by either a crane or fork lift truck. Lifting with a crane, the rope or cable sling should be arranged as shown, Figure 1. NEVER LIFT MACHINE WITH ROPE OR CABLE AROUND SPINDLE, BED OR TAILSTOCK. The rope or cable must be capable of withstanding a weight of 2,000 pounds.

When using a lift truck, adjust forks to go in between top planks of skid and bottom of pedestal base. Lift machine slowly, checking to see that the correct balance is obtained. Use caution, as machine has somewhat more weight at the front and is more easily tipped using the lift truck method than the crane and sling method.

After skid has been removed, place machine directly on location where it is to be used.

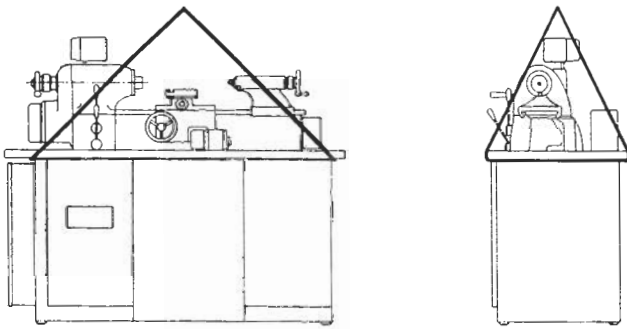

Figure 1 — Lifting Machine With Sling

MACHINE FOUNDATION

The HLV-H Tool Room Lathe will operate without the need of special foundations. A substantial wood or concrete floor, fairly flat and of sufficient strength to support machine properly, is satisfactory. Do not locate machine near equipment that causes vibration which will transmit to the machine, as poor work finish may result.

LEVELING MACHINE

The HLV-H Tool Room Lathe has a three-point arrangement between bed and pedestal base which makes accurate leveling unnecessary. Leveling should be such as to be reasonable and so that, when coolant is used, it will drain back into sump from ends of pan.

There is an adjustable foot at the right rear corner of the pedestal to compensate for uneven floor conditions. To adjust foot, loosen socket set screw and raise or lower foot with a pin wrench so that all four feet rest firmly on the floor. Tighten socket set screw to retain setting.

Should floor conditions be such that adjustable foot is inadequate for leveling, it may be necessary to use shims under pedestal feet.

REMOVE THE RED CLAMP which is located inside the motor compartment under the headstock. The clamp was installed to make a rigid connection between the bed and pedestal base FOR SHIPPING ONLY. Remove cloth wrap and rust-proof paper from variable speed drive assembly. Remove two styrofoam blocks from pulley assembly.

CLEANING MACHINE

USE A CLOTH OR BRUSH TO CLEAN THE HLV-H TOOL ROOM LATHE. DO NOT CLEAN MACHINE WITH COMPRESSED AIR. The use of compressed air for cleaning reduces the life of the machine as small particles of dirt and other foreign matter may be forced past seals and wipers into slides and bearings.

After machine has been properly located, leveled, AND SHIPPING CLAMP REMOVED, wash off all shipping grease, oil and dirt accumulated in transit with a good grade of grease solvent.

Clean motor compartment. Remove all grease from pulleys and brake drum and wipe dry. Rotate pulleys by hand to see that all grease has been removed. DO NOT REMOVE LUBRICANT FROM COUNTERSHAFT.

Remove all shipping grease from variable speed vertical screw "A", Figure 2. Lubricate nut at grease fitting "B" with Houghton Cosmolube #2 and oil vertical screw with light oil for first "Run-In" only. Lubricate grease fitting "B" monthly or more often if necessary. Add a few drops of spindle oil to brake drum "C", Figure 3. Clean tool storage compartment. Put bottom tool shelf in place. See page 8 for additional lubrication points.

ELECTRICAL CONNECTIONS

The Hardinge HLV-H Tool Room Lathe is shipped completely wired and assembled. Remove fibreboard cover and connect electrical power to line side of disconnect switch "D", Figure 4, in machine switch case. Entrance to switch case is made at any convenient place. Ground connection is made at point "E". DO NOT OPERATE SPEED CHANGE MECHANISM UNTIL SPINDLE ROTATION HAS BEEN CHECKED.

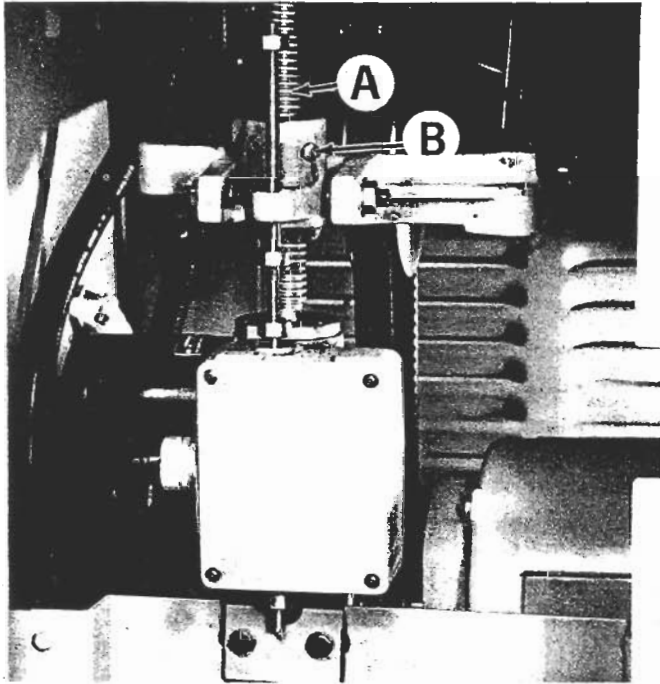

Figure 2 — Speed Change Mechanism

Figure 3 — Spindle Brake

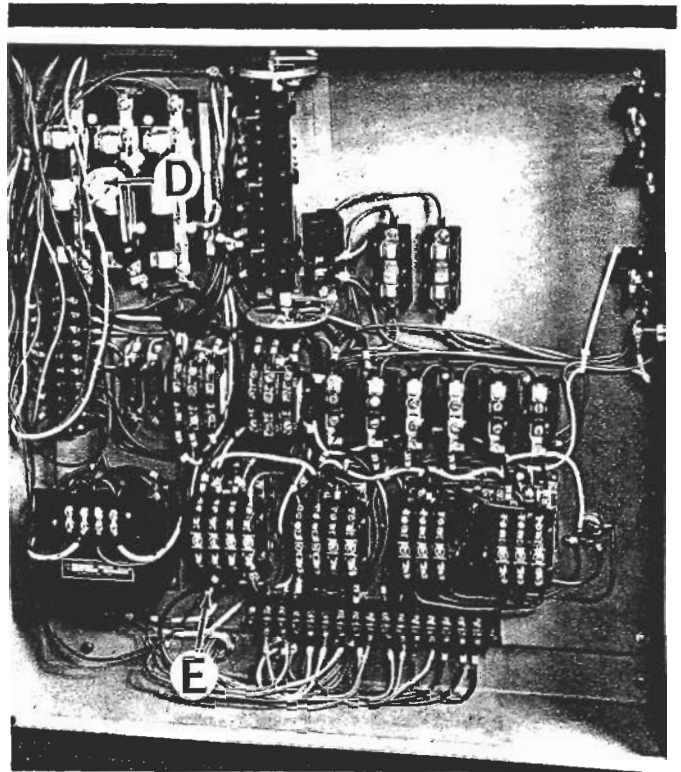
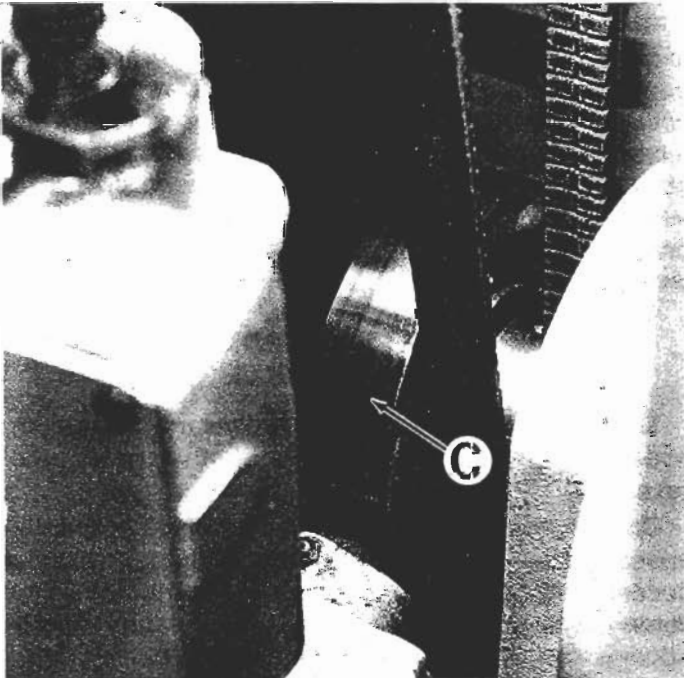
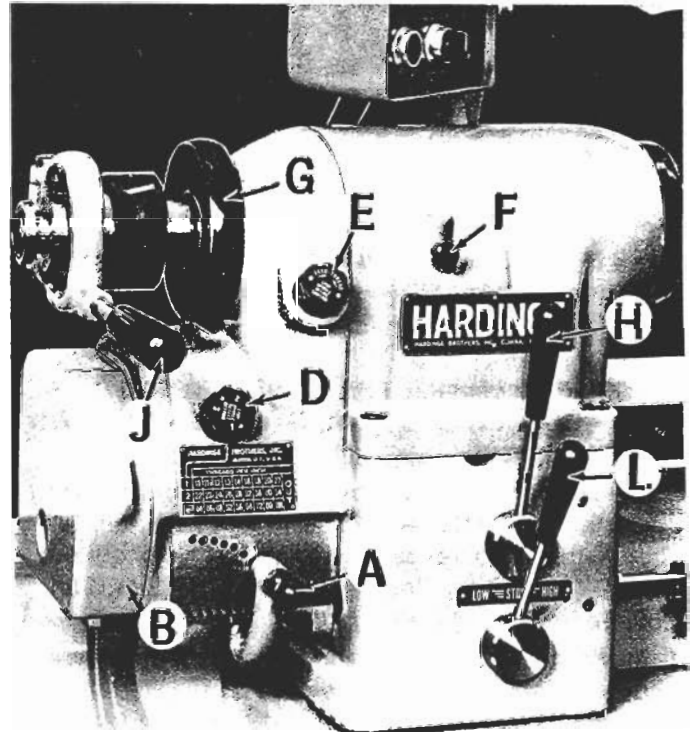

Figure 4 — Electric Switch Case

TO CHECK ROTATION OF SPINDLE, apply a collet to the machine spindle to anchor collet closer. Close switch case door and turn disconnect switch to "On". Pull out spindle lock pin "F", Figure 5, turn spindle switch "G", Figure 6, to "Forward" and brake switch "H", Figure 7, to "Off". Close collet with lever "J", Figure 5. Push start button "K", Figure

Figure 5 — Headstock and Gearbox



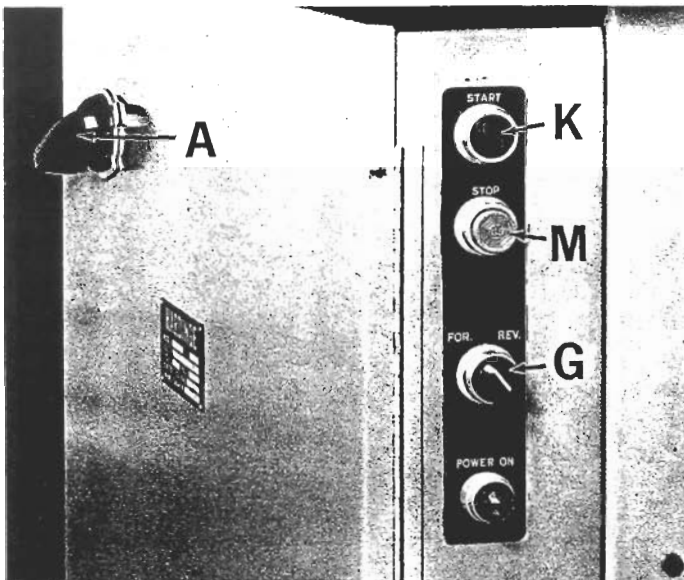

Figure 6 — Switch Case Controls

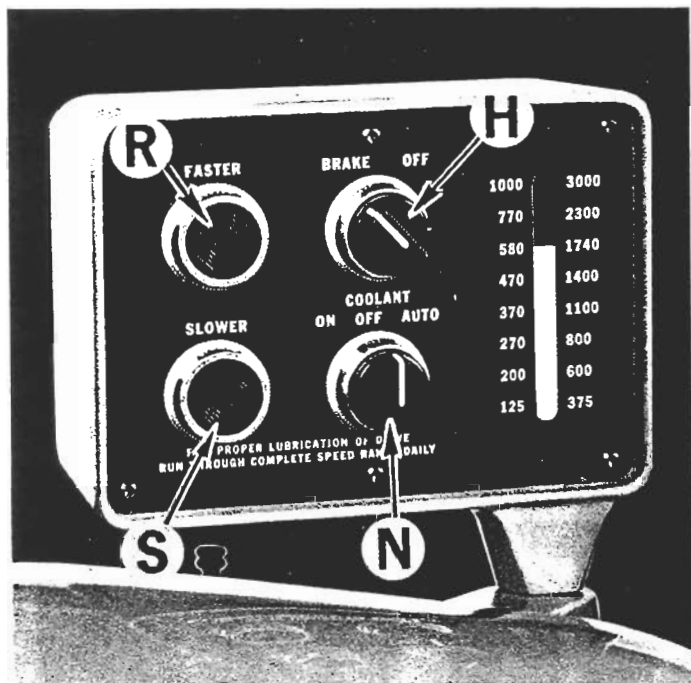

Figure 7 — Control Head

6. Place control lever "H", Figure 5, in center or vertical position. Place lead screw nut handle "M", Figure 11, to left (counter-clockwise) position. Jog spindle by moving lever "L", Figure 9, from Low to Stop in rapid succession. THE SPINDLE TURNS CORRECTLY COUNTER-CLOCKWISE AS VIEWED FROM TAILSTOCK END OF MACHINE.

If the spindle does not turn in the correct direction, DISCONNECT ELECTRIC POWER SOURCE, and interchange any two leads at line side of disconnect switch "D", Figure 4. Secure switch case door. Turn disconnect switch "A", Figure 6, to "On".

If the power should be connected incorrectly and the speed changing mechanism operated, the drive will run all the way to the top or bottom and trip a safety limit switch. To back the drive off the safety

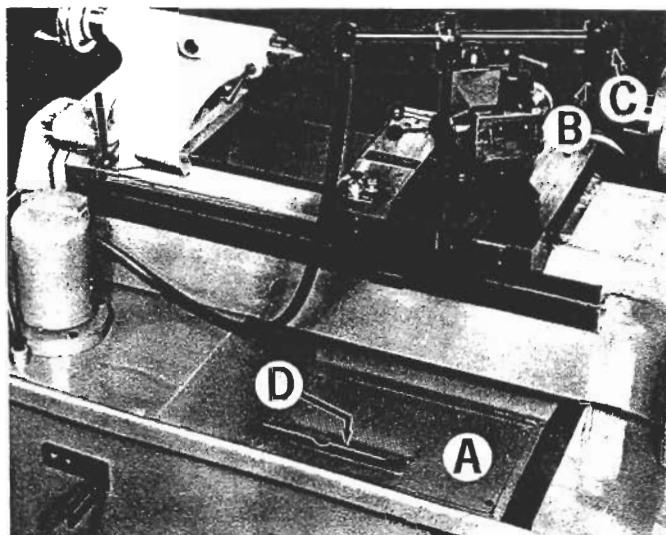

Figure 8 — Coolant Facilities

limit switch, push "STOP" button "M", Figure 6. Turn the variable speed operating screw "A", Figure 2, by hand three full turns to raise or lower driving unit off the safety limit switch.

COOLANT FACILITIES

Fill coolant reservoir with desired coolant by pouring directly into pan at "A", Figure 8.

There is an adjustable nozzle, "B", which directs the coolant to the work piece. Coolant flow is controlled by knob "C".

Coolant pump switch "N", Figure 7, should be set at "OFF" unless using the coolant supply. When coolant pump switch "N" is set to ON position, coolant pump will run continuously. If pump switch is set at AUTO position, coolant will flow only when spindle is running.

- CAUTION -

USE PETROLEUM BASED CUTTING FLUIDS ONLY. IF WATER BASED COOLANTS ARE USED, THE MACHINE WARRANTY WILL BE VOIDED.
02/19/93

Clean sump regularly, depending upon type of material being run. When machining cast iron or other powdery material without coolant, close sump screen cover "D", Figure 8, to prevent powdery material from mixing with coolant. To clean sump, remove the four screws, one in each corner of the screen cover for sump. Lift screen cover from sump. Rinse out and drain sump by removing pipe plug from bottom of sump at back of machine.

OPERATING INSTRUCTIONS SPINDLE DRIVING UNIT

The driving unit provides infinitely variable spindle speeds from 125 to 3000 R.P.M., both forward and reverse.

Control lever "L", Figure 9, controls the spindle speed change from "High" to "Low" range, which is accomplished through the 3:1 ratio motor. The solenoid-operated brake will be automatically applied when lever "L" is in center position.

Control lever "H" reverses direction of carriage for threading only. ALWAYS PLACE THIS LEVER IN CENTER POSITION BEFORE STARTING MACHINE.

Knob "E" is used to connect or disconnect the threading gear box from the headstock spindle by means of a sliding gear. ALWAYS SHUT OFF MACHINE BEFORE ENGAGING OR DISENGAGING. Turn knob "E" clockwise to "Feed" position to disconnect gearbox. IMPORTANT: Knob "E", should always be in "Feed" position unless threading, thus disconnecting gear box from headstock spindle. See page 10 for complete thread cutting instructions.

TO START SPINDLE, pull out lock pin "F", Figure 9, press "Start" button "K", Figure 6, and move control lever "L", Figure 9, to "Low" or "High" position to start spindle. Move lever "L" to "Stop" position and push button "M", Figure 6, to shut machine off. Selector switch "G", Figure 6, controls direction of headstock spindle rotation.

The Hardinge HLV-H Tool Room Lathe is designed for rapid acceleration to high speeds. BEFORE mounting large fixture work or a heavy jaw chuck, run speed change mechanism to low spindle speed. Unusually large or heavy work, or work not properly balanced, will cause excessive vibration at high speeds.

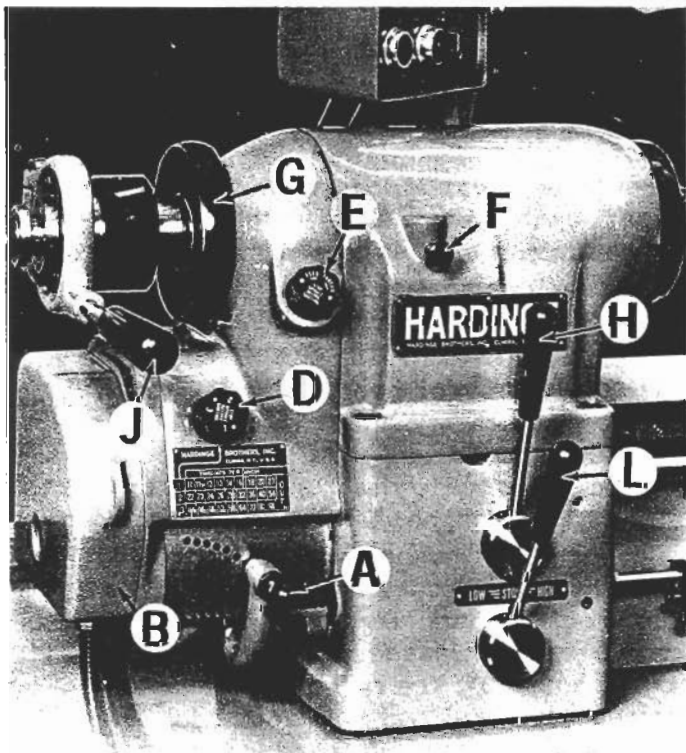

Figure 9 — Control Levers

SPINDLE LOCK PIN

The spindle lock pin "F", Figure 9, is used to hold the headstock spindle stationary when applying or removing spindle nose attachments, adjusting collet closer, or when applying and removing work from fixtures or a threaded arbor. To engage lock pin "F", turn spindle by hand and push in until pin enters one

of the notches of the spindle assembly. THE LOCK PIN IS ELECTRICALLY INTERLOCKED WITH THE MAIN DRIVE MOTOR AND MUST BE WITHDRAWN BEFORE MACHINE WILL START.

FREE SPINDLE

To obtain a "Free Spindle" for easy turning of the headstock spindle by hand, place operating lever "L", Figure 9, in "Stop" position, push start button "K", Figure 6, and turn brake switch "H", Figure 7, to "Off" position.

CHANGING SPINDLE SPEED

To change spindle speed, start spindle and push button "R", Figure 7, to increase speed, and button "S" to decrease speed. Hold button until desired speed is indicated in sight window. Speeds in left-hand column are obtained with lever "L", Figure 9, in "Low" position, and speeds in right-hand column are obtained with lever "L" in "High" position. The spindle speeds should be selected to suit each particular job, depending on material, type of cut and tool to be used.

FOR PROPER LUBRICATION OF DRIVE, RUN THROUGH COMPLETE SPEED RANGE DAILY.

SPINDLE BRAKE

The spindle brake is built for rapid but gradual stopping of the precision headstock spindle at all speeds. The brake is automatically applied when lever "L", Figure 9, is placed in center position and selector switch "H", Figure 7, is in "Brake" position.

The brake drum "C", Figure 3, is located directly on the main drive shaft. The brake insert is forced against the brake drum by spring action and solenoid released. The spring automatically compensates for brake wear. DO NOT ALLOW CORK INSERT TO BECOME DRY. Oil occasionally with a few drops of spindle oil. Allowing cork to become dry will reduce belt life excessively.

MACHINE SERIAL NUMBER

The serial number for the HLV-H Tool Room Lathe is located at the rear of the bed at the tailstock end, see Figure 10. The machine serial number should be included in all correspondence regarding this machine.

TAILSTOCK

The tailstock is securely anchored to the dovetail bed with locking lever "A", Figure 10. To properly lock tailstock on center, lever "A" should be against stop pin "B". The hardened and ground spindle is divided in $\frac{1}{8}$ " increments for the full $3\frac{3}{4}$ " travel. The handwheel has a black and white friction adjustable dial reading in .001" increments. To adjust dial for zero reading, hold handwheel and turn dial with fingers.

The tailstock spindle takes standard No. 2 Morse

Taper shank centers and other tailstock tooling. See page 26.

To lock spindle in position, move lever "C" clockwise as viewed from machine rear. Standard shank tooling is automatically ejected when spindle is returned beyond zero reading on spindle.

CARRIAGE AND COMPOUND SLIDE

The HLV-H carriage and compound slide (tool post slide) feature easy reading black and white dials and completely covered feed screws. The tool holder takes standard $\frac{3}{8}$ " square tool bits.

The tool holder has a screw feed wedge arrangement for fast, accurate and rigid use. The wedge adjustment maintains proper cutting edge clearance by keeping the cutting tool in a horizontal plane at all points of adjustment when placing the tool cutting edge on center.

To raise or lower cutting tool, loosen lock screws "A", Figure 11, and turn screw "B" accordingly.

The compound slide swivels for turning angles or to set for threading.

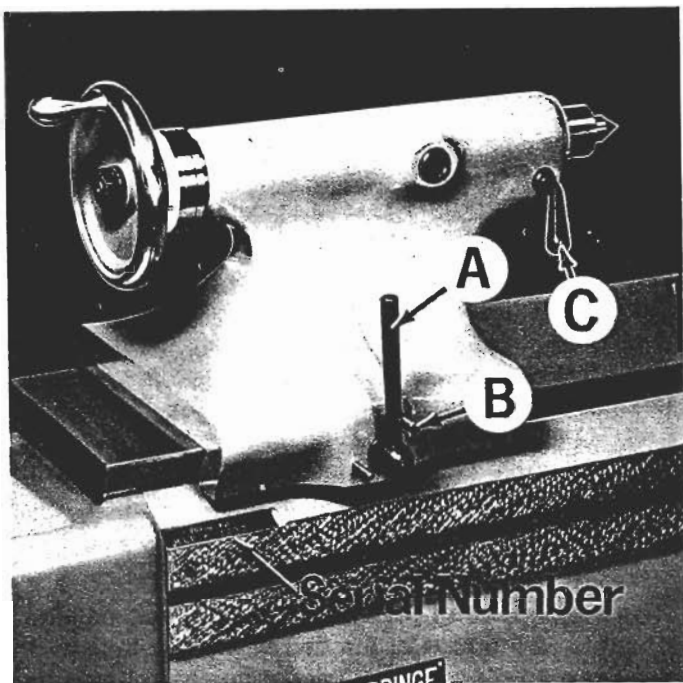

Figure 10 — Tailstock

To make precision angular setting of the tool post slide, loosen eccentric lock "C", Figure 12, to permit top slide to be swiveled. Angular setting is visible at point "D", Figure 11. When tightening draw bolt, turn clockwise as you would right-hand thread.

The carriage handwheel "E" is used to manually feed carriage (longitudinal movement) during set-up or to point where power feed is engaged. The dial is graduated in increments of .010". To change dial zero setting, loosen lock screw "F", Figure 11. The ball crank handle "G" is used when manually

feeding cross slide while setting up or to point where power feed in, engaged. The dial is graduated in increments of .001" and is direct reading—each graduation indicates a change of .001" on diameter of work piece. To change zero setting of dial, loosen lock screw "H", Figure 12.

The ball crank handle "J", Figure 11, is used to position the tool post slide. The black and white dial is graduated in .001" increments. To change dial zero setting, loosen lock screw "K".

Carriage lock "L" is used to lock carriage in a fixed position on the bed when doing heavy facing operations. To lock carriage position, pull handle forward.

Lead screw nut handle "M" is for threading only. Move handle to left (counter-clockwise) position to disengage.

The quick acting handle "N" for compound slide, is used when threading or turning to withdraw tool for return of carriage.

POWER FEED FOR CARRIAGE AND CROSS SLIDE

The power feed clutches are of the friction type designed to slip when overloaded, which protects the tool as well as the machine. The clutches are spring loaded and cannot be adjusted for more pulling power. If the clutch slips under cut, it is a sign of improper or dull tool or excessive feed.

Clutch handle "O", Figure 11, is raised to engage carriage longitudinal power feed. To release clutch, press lever down. Clutch handle "P" controls cross slide power feed—handle "Up" to engage and handle "Down" to disengage clutch.

The carriage and cross slide power feed is powered by a direct current, totally enclosed, ball bearing motor mounted on the carriage apron.

To start the power feed, position selector "A", Figure 13, to "Left" position. Switch "A" is used to reverse the power feed motor. Machine must be running before power feed will operate. With switch "A" in "Stop" position, power feed motor is off.

In operation, the carriage or cross slide is advanced with respective handwheel until the cutting tool is next to work. Then, the proper clutch is engaged. The rate of feed is increased or decreased by turning knob "B". The rate of feed is determined by material being cut and finish required. The rate of feed may be changed while tool is under cut. Experience has shown that it is best to make a few sample pieces to determine the spindle speed and rate of feed that is best suited to give desired surface finish and production rate. When making the test run, record the number at which the knob "B" was set when best results were obtained. Then, on the production run, the operator can set the control knob to the reference numbers. Numbers are for reference only and do not represent either thousandths per revolution or inches per minute.

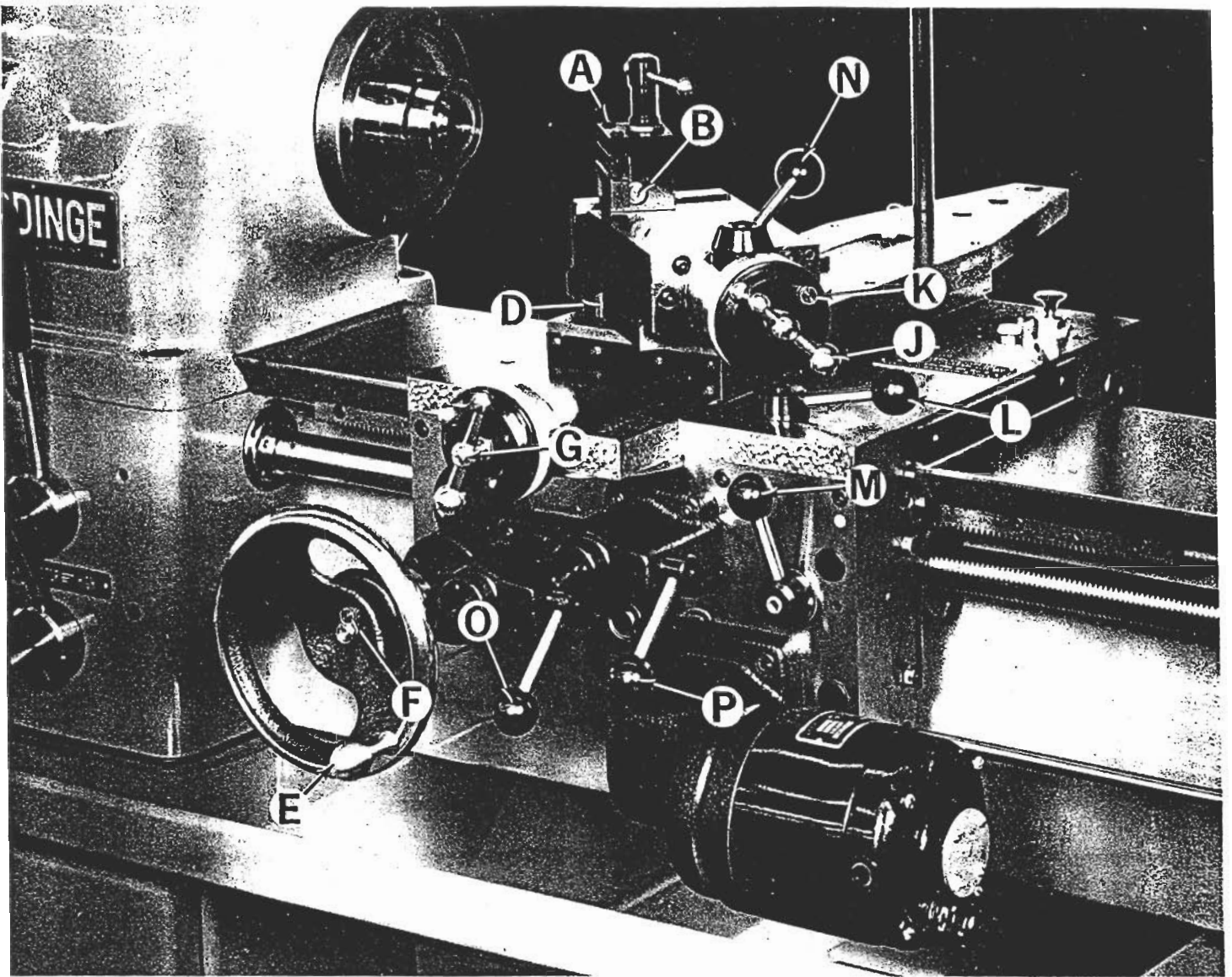

Figure 11 — Carriage and Compound Slide

Figure 12 — Power Feed Clutches

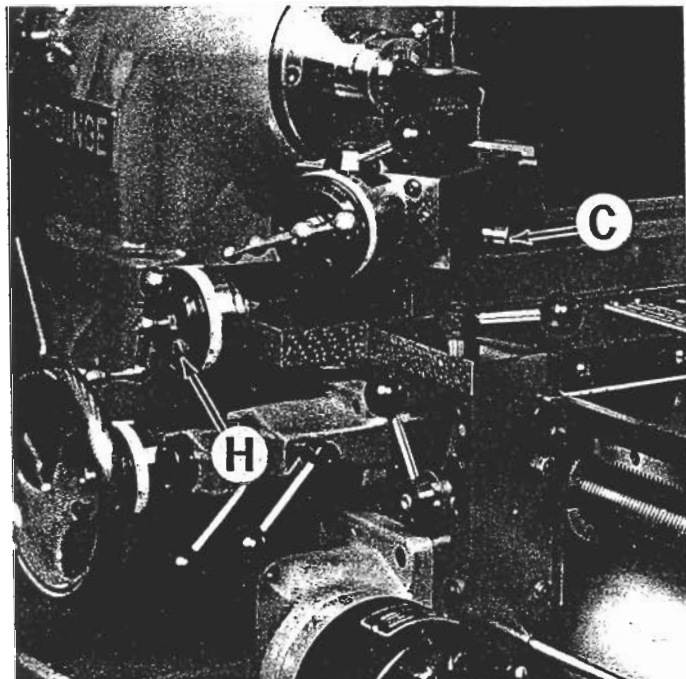

Figure 13 — Power Feed Control Box



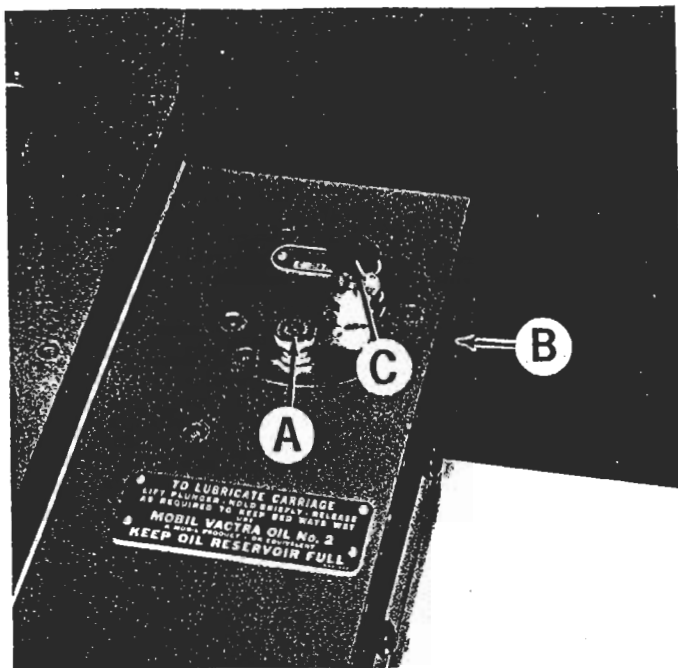

Figure 14 — Carriage Pressure Oiler

CARRIAGE LUBRICATION

Keep oil reservoir "A", Figure 14, full with Mobil Vactra Oil #2 or equivalent. Maintain oil level in sight window "B". To lubricate carriage and bed ways, lift plunger "C". HOLD BRIEFLY AND RELEASE, ALLOWING PLUNGER TO RETURN OF ITS OWN ACCORD.

Operate pressure oiler as often as required to keep bed ways wet, or a minimum of once daily.

Clean and use pressure oil can to LUBRICATE CARRIAGE GEAR RACK, LEAD SCREW AND LEAD SCREW NUT with light oil weekly.

APRON AND CLUTCHES LUBRICATION

Keep oil in apron assembly in sight window "D", Figure 15. Add oil by removing cap "E". Use automatic transmission fluid Mobilfluid 350 or equivalent. CHANGE OIL EVERY 60 DAYS. To drain oil remove magnetic drain plug at underside of carriage apron.

GEAR BOX LUBRICATION

Lubricate gears in gear box every three months, or more often if necessary, with KLING GREASE. If long periods exist when threading unit is not shifted, operate monthly, thread-feed knob, three-change knob and nine-change handle from one extreme to the other several times.

Lubricate bushings and shafts on change gear bracket with spindle oil. If long run threading is involved, lubricate daily.

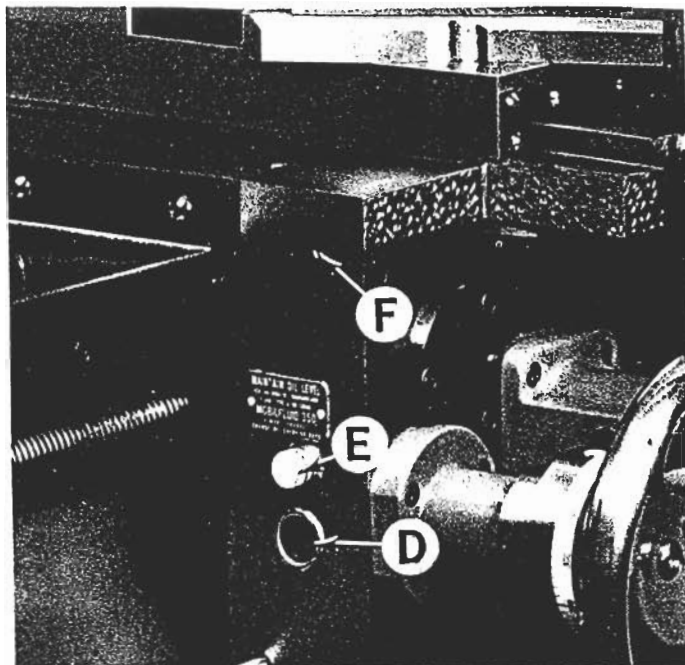

Figure 15 — Apron Lubrication

COLLET CLOSER REMOVAL

The collet closer should be removed weekly and between set-ups for cleaning to prevent loading of chips between collet closer tube and inside of spindle at rear end and collet threads.

Remove collet closer when using jaw chucks, face plates, fixture plate or other nose type fixtures.

Running the machine with the collet closer in place without a collet may cause damage to the collet closer.

1. Remove link pin "A", Figure 16, only. This pin is easily removed by pulling up and out with fingers.
2. Remove collet closer as shown, Figure 17. To remove adjusting nut "B", pull straight off end of spindle. DO NOT TURN ADJUSTING NUT—IT IS NOT THREADED TO SPINDLE.

COLLET CLOSER REPLACEMENT

1. Clean inside of the headstock spindle before applying collet closer. Also clean outside diameter at rear of spindle where adjusting nut locates. Clean collet closer tube inside and out.
2. Apply a film of light oil on rear of headstock spindle and replace adjusting nut "B", Figure 17. DO NOT FORCE ADJUSTING NUT ON SPINDLE. If adjusting nut goes on tight, remove and examine for burrs or scratches. Apply a film of light oil on bearing section "C" of collet closer tube, replace closer and insert link pin "A", Figure 16.

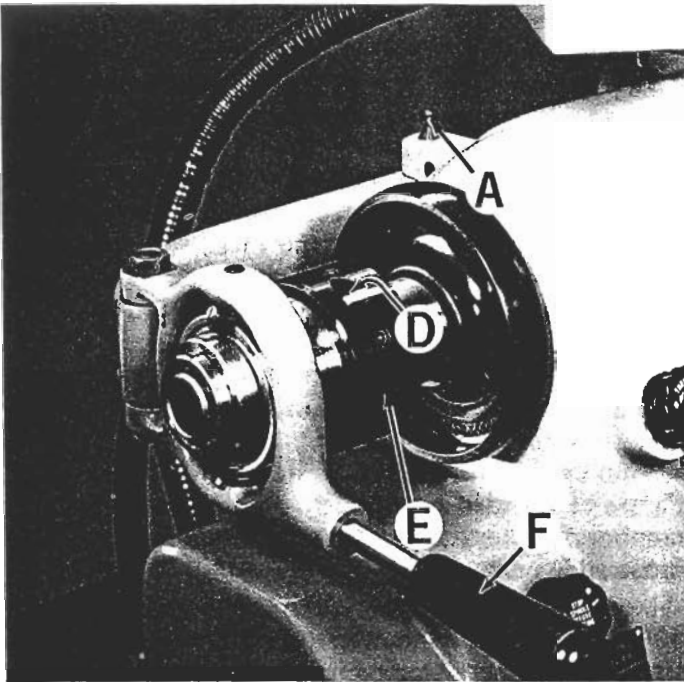
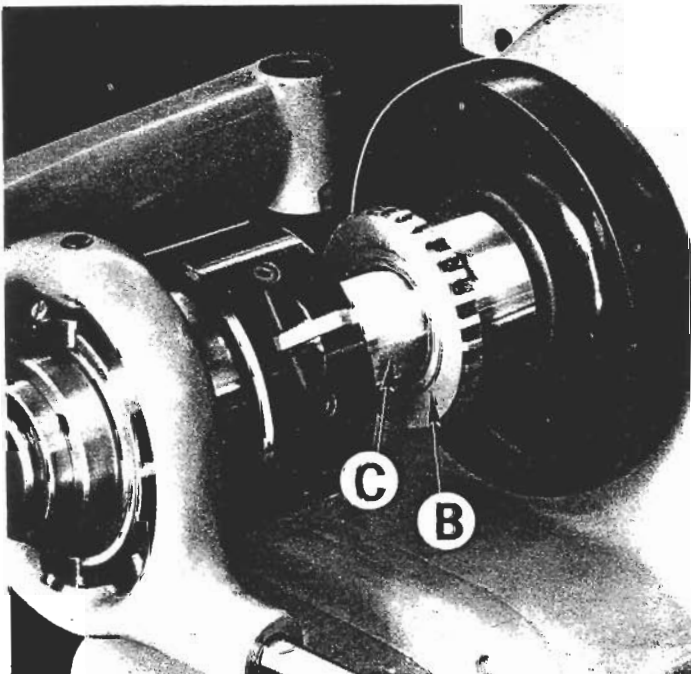

Figure 16 — Collet Closer

TO ADJUST COLLET CLOSER

1. Apply the desired size collet or step chuck to the machine spindle. COLLET OR STEP CHUCK AND SPINDLE MUST BE CLEAN.
2. Open collet closer latch "D", Figure 16, by pressing down at point "D".
3. Engage collet closer tube on collet or step chuck and thread about two turns only. To turn the collet closer tube, the operator turns the black shell guard "E" forward with his left hand while holding the collet or step chuck in place with his right hand.
4. Place a work piece in collet or step chuck.

Figure 17 — Collet Closer Removal



5. Move lever "F", Figure 16, to the extreme left or closed position. Push in lock pin "F", Figure 20. To engage lock pin, turn spindle by hand until pin enters notch to lock. Turn shell guard "E", Figure 16, toward operator until it is drawn up as far as it will go by hand.
6. Move lever "F" forward to the released position and turn shell guard "E" toward operator so that latch "D" advances two notches on the adjusting nut.
7. Close latch "D" and test collet closer for tension on work. Should additional gripping pressure be required, open latch "D" and turn shell guard "E" toward operator. For less gripping pressure, turn shell guard "E" away from operator.

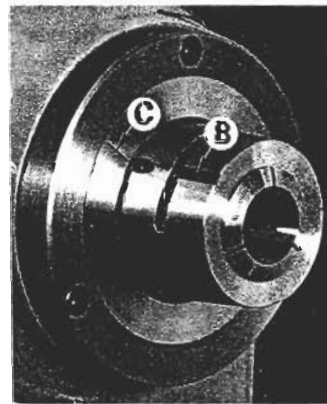

Figure 18



Figure 19

Application of Spindle Nose Tooling

TO APPLY AND REMOVE SPINDLE NOSE TOOLING

The Hardinge taper nose spindle construction is time-proven for accuracy, durability and for fast, easy application and removal of spindle nose tooling. The precision ground taper holds and aligns all tooling.

TO APPLY spindle nose tooling, engage lock pin "F", Figure 20. Align key "A", Figure 19, with bayonet slot "B", Figure 18, and slide tooling on spindle nose. Turn clockwise or counter-clockwise to lock in place. Once securely drawn up, the spindle nose tooling is actually driven by the locking action of the tapered surfaces. Final tightening should be done with a standard pin type spanner wrench. (Use Williams or Armstrong spanner wrench No. 460.) DO NOT USE HAMMER AND PUNCH.

TO REMOVE spindle nose tooling, turn with spanner wrench until key "A", Figure 19, is in line with reference mark "C", Figure 18, on spindle. DO NOT REMOVE KEY "A" TO REMOVE SPINDLE NOSE TOOLING.

THREAD CUTTING

Caution: Do not run spindle in reverse when threading.

The Hardinge HLV-H Lathe is designed for rapid and accurate thread cutting. The quick change gear box permits instant selection of 27 different threads. Threads can be cut to a shoulder without fear of running into the shoulder since the automatic stops will limit carriage travel at a predetermined point in either direction.

Before starting to cut a thread, select the proper cutting speed for the size of thread to be cut and to give the best finish for the particular material being used. **Maximum recommended threading speed is 1000 R.P.M.**

Set the quick change gear box for desired pitch. To make a selection on the gear box thread chart, pull the spring-pressured black knob "A", Figure 20, out as far as it will go and lower it until it will move sideways to the desired notch directly under the thread required. Raise the handle and let plunger drop into hole. If the tumble handle will not raise far enough to position plunger into hole, open change gear cover "B" and rotate shaft "A", Figure 21, until gears mesh and handle raises, permitting plunger to seat.

DO NOT SHIFT GEARS WHILE MACHINE IS RUNNING.

Set three-change knob "D", Figure 20, for number corresponding with left side of gear box thread chart. Set knob "D" so desired number is in bottom position in line with arrow. In the event the sliding gear cluster does not engage the other gears in gear box properly to bring the desired number on three-change knob "D" in line with arrow, open the change gear cover "B" and Turn shaft "A", Figure 21, by hand until gears mesh.

Engage the gear box by turning knob "E", Figure 20, counterclockwise in the direction of arrow marked "Thread". When turning knob "E", the teeth of the sliding gear within the gear box may not mesh with the headstock spindle gear teeth. If this is the case, turn headstock spindle with handwheel "G" while turning knob "E" to left until definite click is heard.

Set compound slide at 61° (see page 6), and position cutting tool in compound slide tool post. Position carriage with handwheel so threading tool is in the center of the part to be threaded.

Carriage control lever "H", Figure 20, when moved to the left will cause carriage to move to the left. When the carriage control lever is moved to the right, the carriage will move to the right. Carriage travel can be stopped at any time by placing control lever "H" in center position. Place lever "H" in center position. NOTE: Carriage power feed unit is not used for threading operations.

Engage lead screw nut "A", Figure 23, by moving

ball handled lever "B" clockwise. Set two carriage stops "C" approximately 1/2" from end of carriage. Loosen screw "D" to make area location of stops. Loosen lock screw "E" and turn stop screw "F" to make fine adjustment. With threading tool away from work toward operator, make a trial run with the carriage. Pick up the exact relation between the tool and the shoulder or end of the thread by using tool post slide. Run carriage to right, checking stop. Make adjustments so tool will clear end of work by 1/4".

CAUTION: Lock carriage stops securely before starting to cut threads. Do not release carriage nut "A" until threading operation is completed.

With carriage at rest and quick acting handle "N", Figure 11, forward in cutting position, feed the desired number of thousandths for each threading pass using cross slide handwheel "G", Figure 11.

Move lever "H", Figure 20, to the left and carriage will travel until it contacts stop at headstock end of machine. The headstock spindle will continue to run. Carriage stops cause only the gear box, lead screw and carriage to stop.

After each pass, withdraw threading tool from work with quick acting handle "N", Figure 11, and return carriage to starting position by moving carriage control lever "H", Figure 20, to the right.

LEFT HAND THREADS can be cut the same as right hand with the spindle running "forward" except cutting pass is made from the headstock toward the tailstock. Carriage control stops are used for left hand threads as well as right hand threads.

Figure 20 — Threading Gear Box

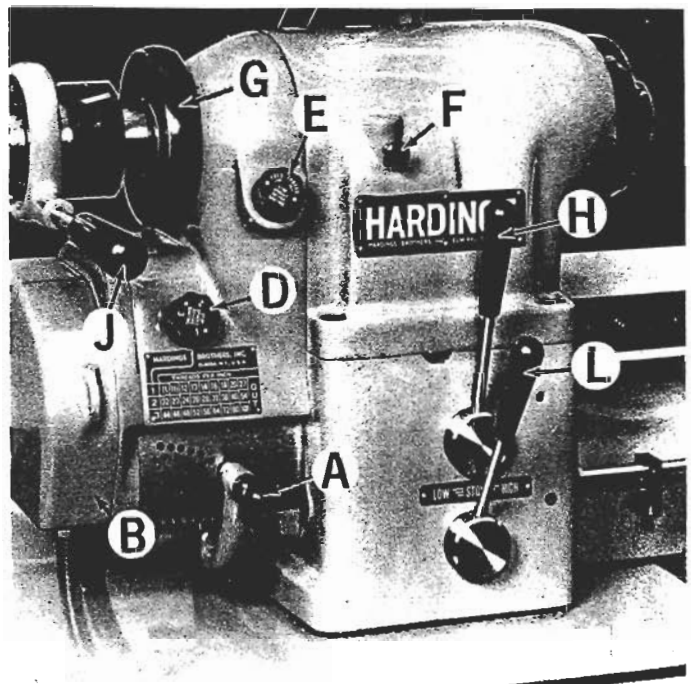

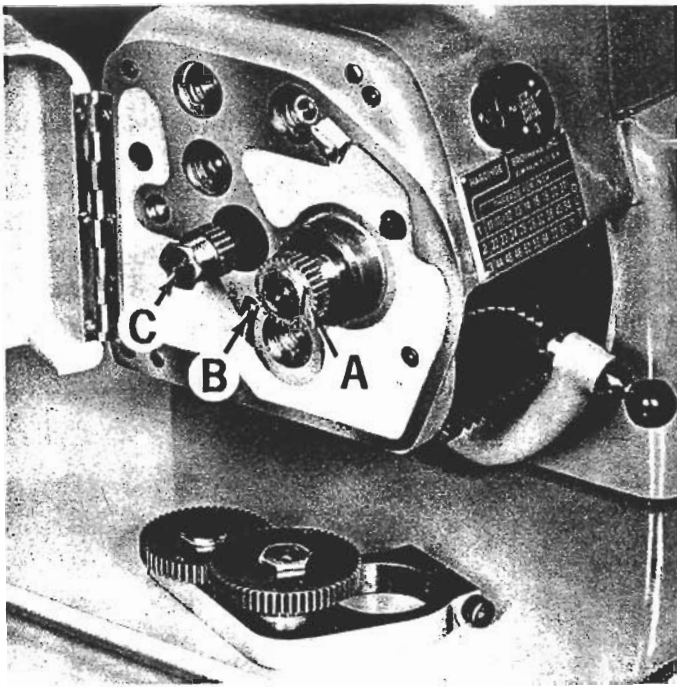

Figure 21 — Threading Gear Box

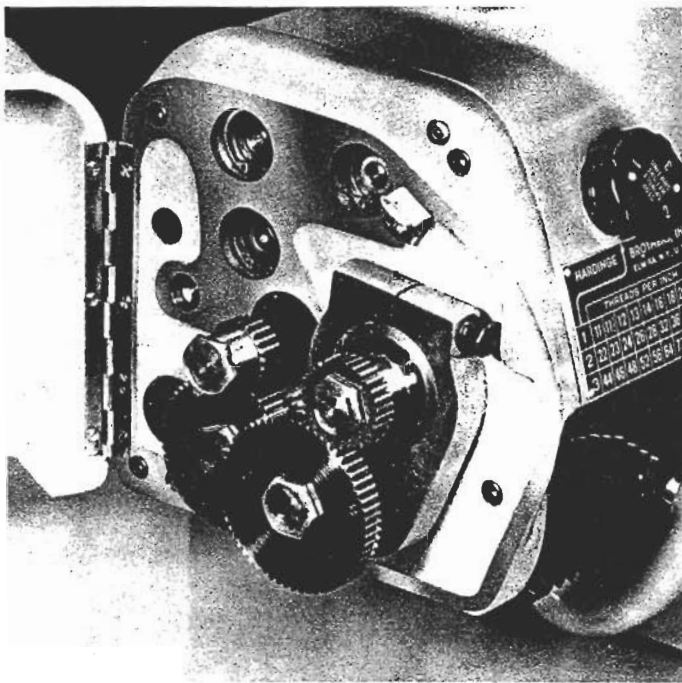

Figure 22 — Threading Gear Box

OUTSIDE CHANGE GEARS

The outside change gears are used to cut threads not provided in the quick change gear box. A set of five gears and a bracket are supplied as standard equipment with each machine. These gears, when set up to the gear chart, page 14, will cut 10 threads per inch. Three of the gears are shipped on the bracket and the other two are in place on the shafts as shown in Figures 21 and 22, one on the end of the lead screw shaft "A", and the other on the end of the sliding cluster gear shaft "C".

BEFORE SETTING UP CHANGE GEARS, PLACE KNOB "A", FIGURE 20, IN THE "OUT" POSITION.

Fastened to the tumbler handle bracket within the gear box is a round safety bar "B", Figure 21, that extends out through a hole in the left side of the gear box. This bar is to prevent applying change gears outside the gear box until the tumbler handle is placed in the "OUT" position.

To cut other threads which are not available through gear box, additional gears are available.

Lubricate bushings and shafts on change gear bracket with spindle oil each time a set-up is made. If long run threading is involved, lubricate daily.

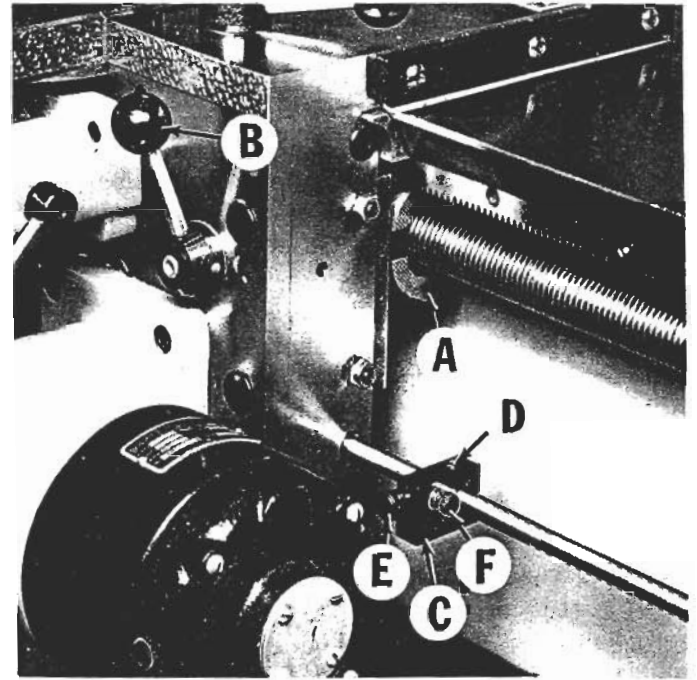
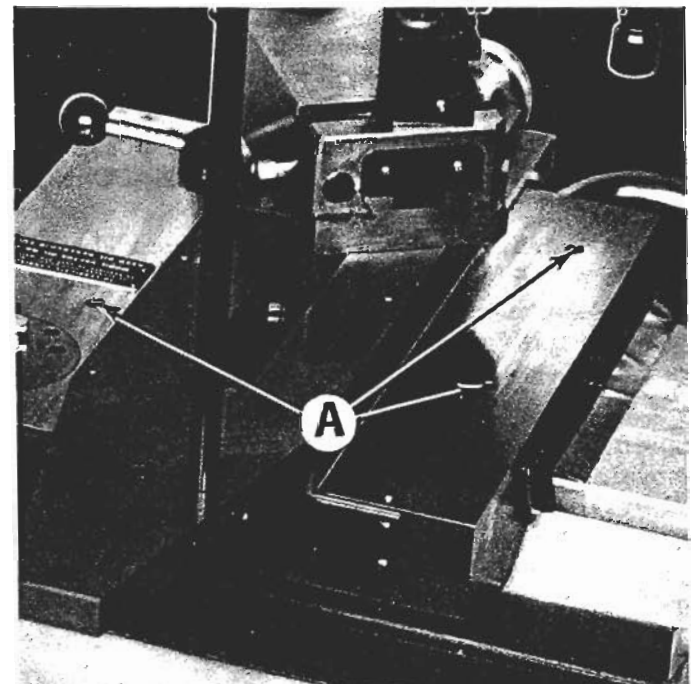

Figure 23 — Thread Length Control

Figure 24 — Tool Mounting Holes



METRIC THREADS

By the application of a metric attachment to the gear box, in place of the English bracket for the outside change gears, metric threads can be cut by the same procedure as when setting up English threads. See Metric Thread Chart, Page 15.

Gears supplied for the English outside gear arrangement can also be used in the gear setup for metric threads.

When metric attachment is supplied with machine, a large gear cover is shipped as standard equipment. When the metric attachment is supplied later, the large cover is included to replace the standard cover.

TOOLING

To permit ease of mounting of various tooling items, holes are drilled and tapped in anticipation of use. The following is a list of such items and the location of mounting holes. Other items listed require special instructions.

FOLLOW REST, Page 18, is mounted directly to the carriage. To apply the follow rest, remove three plug screws "A", Figure 24. Replace screws "A" after using follow rest to keep holes free of chips.

MOTOR GRINDER, Page 19, mounts directly to the compound slide T-slot. When grinding, keep as much of the bed, carriage and apron, as possible, covered with oil-soaked cloths to prevent abrasive material from causing machine damage.

TAPER TURNING ATTACHMENT, Page 19, mounts directly on the back of the lathe bed and is adjustable along the T-slot to suit the work.

In operation, the taper turning attachment is moved into position to suit the work by loosening two nuts "J", Figure 25. Clean attachment of all chips and foreign matter.

Position the cross slide so bolt "A" can be placed through any one of the three holes "B" in the cross slide to engage shoe "C". With the cutting tool in position and taper attachment secured to cross slide, release $\frac{9}{16}$ " cap screw "D" two turns—DO NOT REMOVE SCREW "D".

To set guide bar "E" to the desired angle, loosen cap screw "F". Screw "F" is located on the underside of the taper attachment body. Swing guide bar "E" to desired angle or taper per foot according to graduation viewed through zero plate "G".

Lock guide bar in place with screw "F" and tighten screw "A". Make a test cut. It may be necessary to move guide bar a very small amount to obtain the exact taper for a blued fit to the taper gage. Loosen screw "F" and "A" a very small amount and tap guide bar lightly on hardened pins "H", Figure 26, to move it into position to give exact taper. Lock screws "F" and "A" tight. Lubricate guide bar with spindle oil.

IMPORTANT: When turning or boring a taper, be sure the cutting tool is exactly on center—otherwise, a true taper will not be produced.

When the taper attachment is not in use, keep at tailstock end of bed.

INDICATOR CARRIAGE STOP, Page 20. All HLV-lathes are equipped with a tapped hole "F", Figure 15, in the carriage for mounting the micrometer to the carriage. The bracket carrying the indicator mounts directly to the dovetail bed.

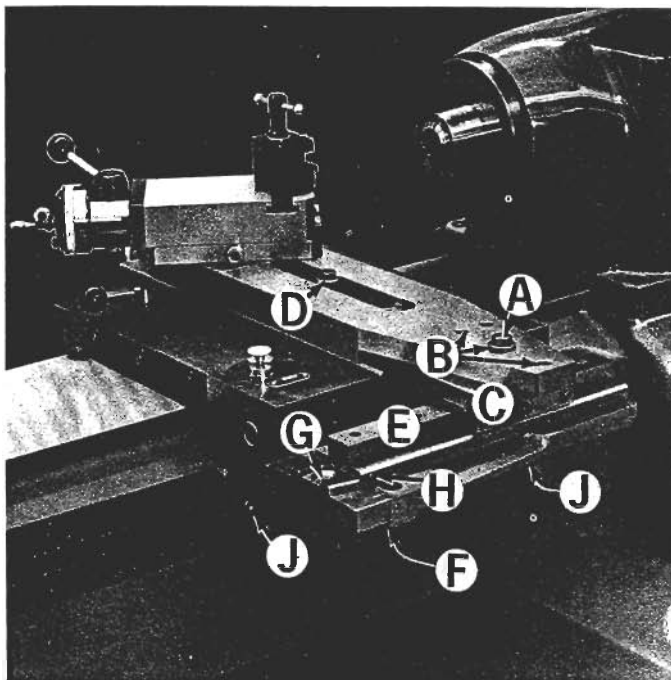
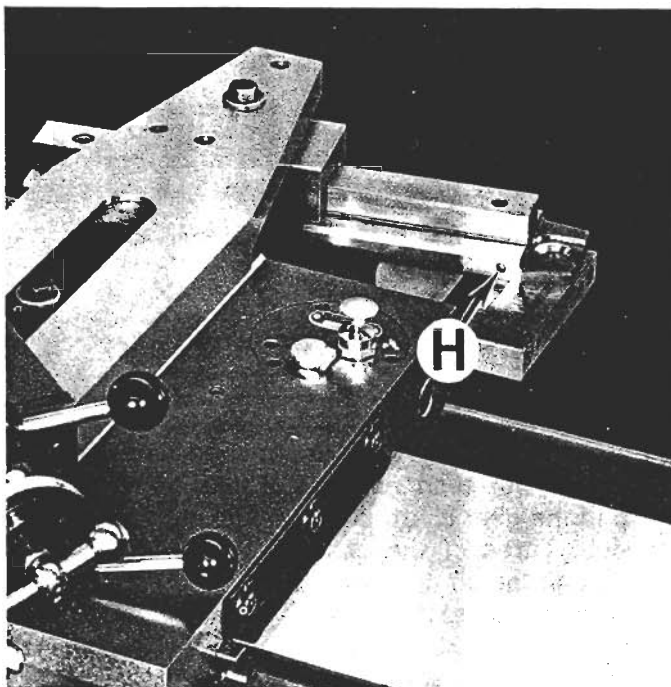

Figure 25 — Taper Turning Attachment

Figure 26 — Taper Turning Attachment



— Specifications —

Spindle Construction	Hardinge Super-Precision® Preloaded Ball Bearing
Spindle Capacity:	
With Round 5C Collets	1 1/16"
With Hexagon 5C Collets	7/8"
With Square 5C Collets	3/4"
With Step Chucks	1 1/16" to 6"
With Jaw Chucks	5"
With Jaw Chucks (Through Spindle)	1 5/32"
With Expanding Collets	3"
Spindle Nose	Hardinge Tapered
Variable Spindle Speeds	125 to 3000 RPM
Swing Over Bed	11"
Swing Over Carriage	9"
Swing Over Cross Slide	6"
Distance Between Centers	18"
Hole Through Spindle	1 1/4"
Compound Slide Travel	3"
Power Feed Range	1/4" to 7" per minute
Size of Lathe Tool:	
Wedge Type (Standard)	3/8" x 3/8"
Rocker Type (Optional)	3/8" x 1"
Tailstock Spindle Diameter	1 3/8"
Tailstock Spindle Travel	3 3/4"
Tailstock Spindle Taper	No. 2 Morse
Steady Rest Opening	3"
Lead Screw Diameter	1" — 8 Thread
Range of Threads in Gear Box	11 to 108
Number of Thread Changes in Gear Box	27
Actual Threads Cut Through Gear Box — 11, 11 1/2, 12, 13, 14, 16, 18, 20, 22, 23, 24, 26, 27, 28, 32, 36, 40, 44, 46, 48, 52, 54, 56, 64, 72, 80, 108.	
<i>NOTE Standard threads in all standard English systems are included in the foregoing gear box selections</i>	
Weight Complete (approximate)	1700 lbs

— Regular Equipment —

HARDINGE HLV™-H High Speed Super-Precision Tool Room Lathe - consisting of:

- Fully Enclosed Headstock
- Preloaded Ball Bearing Spindle
- Hardened and Precision Ground Taper Nose Spindle with 1 1/16" collet capacity
- Ball Bearing Collet Closer
- Powerful Endless V-Belt Drive
- Quick Change Gear Box with 27 changes for precision threading only
- Set of Five Change Gears
- Completely Enclosed Carriage and Apron with Preloaded Bearings for Apron Pinion Gear
- Independent Electric Variable Power Feed Drive for carriage and cross slide
- Finger Tip Snap-Up Clutches for longitudinal and cross feed
- Preloaded Ball Bearing Lead Screw for threading only
- Automatic Lead Screw Stop with fine adjustable stops
- Quick-acting Tool Post Slide for threading
- Easy Reading HARDINGE Black and White Feed Screw Dials
- Easy Reading HARDINGE Black and White Dial for carriage handwheel
- Solid Full Bearing Carriage with Teflon® Bearing Surface between Carriage & Bed
- Solid Hardened and Ground Steel Dovetail Bed Ways
- Full Bearing Tailstock — No. 2 Morse Taper
- Welded Steel Pedestal with oil type chip pan, coolant sump and individual motorized coolant pump
- Tool Storage Compartment with swing-out revolving Collet Boards
- Magnetic Electric Control Panel with transformer providing 100 volts for push button control circuit; time lag thermal overload relays provide overload protection; low voltage protection is also provided; cam operated, quick make and quick break forward and reverse switches; pilot light; fused disconnect switch interlocked with cover of panel — entire panel is one self-contained unit.
- Machine painted 7B Gray — For other colors price upon application.
- Push Button Control for Variable Speed Drive. Direct Reading Spindle Speed Indicator. Infinitely **Variable Speed** Driving Unit complete with single voltage, 2 speed, reversing motor **with speed range of 125 to 3000 RPM**
- Completely wired and assembled when delivered. For operation on (Specify electrical voltage):
 - 208 Volt 60 cycle 3 phase
 - 230 Volt 60 cycle 3 phase
 - 460 Volt 60 cycle 3 phase
 - 575 Volt 60 cycle 3 phase

*All specifications are subject to change without notice

ENGLISH THREADS

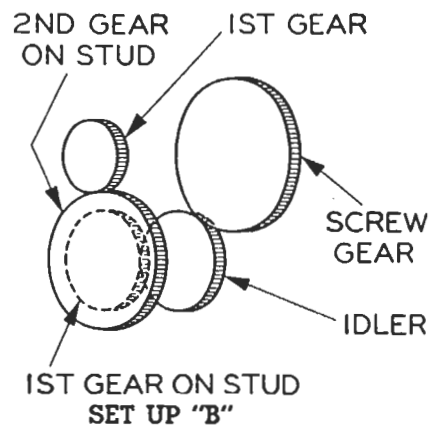
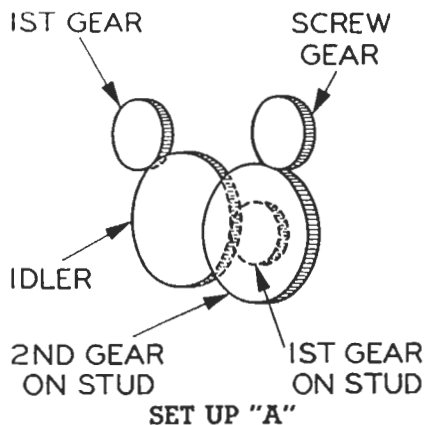

THREADS PER INCH	SET UP	NOB	FIRST GEAR	FIRST GEAR ON STUD	SECOND GEAR ON STUD	SCREW GEAR	IDLER
10	A	2	22*	22*	60*	30*	55*
11				gearbox			
11½				gearbox			
12				gearbox			
13				gearbox			
14				gearbox			
15	A	1	40	30	30	60	44
16				gearbox			
17	A	1	40	34	30	60	44
18				gearbox			
19	A	1	40	38	30	60	44
20				gearbox			
21	A	1	40	42	30	60	44
22				gearbox			
23				gearbox			
24				gearbox			
25	A	1	40	50	30	60	30
26				gearbox			
27				gearbox			
28				gearbox			
29	A	1	40	58	30	60	30
30	A	2	40	30	30	60	44
31	A	1	30	31	22	66	44
32				gearbox			
33	A	1	30	33	22	66	44
34	A	1	30	34	22	66	44
35	A	1	30	35	22	66	44
36				gearbox			
37	A	1	30	37	22	66	44
38	A	2	40	38	30	60	44
39	A	1	30	39	22	66	44
40				gearbox			
41	A	1	30	41	22	66	44
42	A	2	40	42	30	60	44
43	A	1	30	43	22	66	44

THREADS PER INCH	SET UP	NOB	FIRST GEAR	FIRST GEAR ON STUD	SECOND GEAR ON STUD	SCREW GEAR	IDLER
44				gearbox			
45	A	1	30	45	22	66	44
46				gearbox			
47	A	1	30	47	22	66	44
48				gearbox			
49	A	1	30	49	22	66	44
50	A	2	40	50	30	60	30
51	A	1	30	51	22	66	
52				gearbox			
53	A	1	30	53	22	66	44
54				gearbox			
55	A	1	30	55	22	66	44
56				gearbox			
57	A	1	30	57	22	66	40
58	A	2	40	58	30	60	30
59	A	1	30	59	22	66	40
60	A	3	40	30	30	60	44
61	A	2	40	61	30	60	40
62	A	2	30	31	22	66	44
63	A	2	40	42	22	66	44
64				gearbox			
65	A	2	48	52	22	66	30
66	A	2	30	33	22	66	44
67	B	2	30	40	60	67	40
68	A	2	30	34	22	66	44
69	A	2	40	46	22	66	44
70	A	2	30	35	22	66	44
71	A	3	60	33	22	71	30
72				gearbox			
73	A	3	60	33	22	73	30
74	A	2	30	37	22	66	44
75	A	2	40	50	22	66	
76	A	3	40	38	30	60	
77	A	3	60	33	22	77	30
78	A	2	30	39	22	66	44
79	A	3	60	33	22	79	30

* Five gears supplied as standard equipment with machine.

ENGLISH THREADS

(Continued)

THREADS PER INCH	SET UP	NOB	FIRST GEAR	FIRST GEAR ON STUD	SECOND GEAR ON STUD	SCREW GEAR	IDLER
80				gearbox			
81	A	3	40	27	22	66	44
82	A	2	30	41	22	66	44
83	B	3	22	60	83	33	55
84	A	3	40	42	30	60	44
85	A	2	24	34	22	66	44
86	A	2	30	43	22	66	44
87	A	3	40	29	22	66	44
88	A	2	30	44	22	66	44
89	B	3	22	60	89	33	55
90	A	2	30	45	22	66	44
91	B	3	22	60	91	33	30
92	A	2	30	46	22	66	44
93	A	3	40	31	22	66	44
94	A	2	30	47	22	66	44
95	A	2	24	38	22	66	44
96	A	2	30	48	22	66	44
97	B	3	22	60	97	33	55
98	A	2	30	49	22	66	44
99	A	3	40	33	22	66	44
100	A	3	40	50	30	60	30
102	A	2	30	51	22	66	44
104	A	2	30	52	22	66	44
105	A	2	24	42	22	66	44
106	A	2	30	53	22	66	44
108				gearbox			
110	A	2	30	55	22	66	44
112	A	2	30	56	22	66	40
114	A	2	30	57	22	66	40
115	A	2	24	46	22	66	44
116	A	3	40	58	30	60	30
118	A	2	30	59	22	66	40
120	A	2	30	60	22	66	40
122	A	3	40	61	30	60	40
124	A	3	30	31	22	66	44
125	A	2	24	50	22	66	44
126	A	3	40	42	22	66	44
128	A	3	30	32	22	66	44
130	A	3	48	52	22	66	30
132	A	3	30	33	22	66	44
134	B	3	30	40	60	67	40
135	A	3	40	45	22	66	44
136	A	3	30	34	22	66	44
138	A	3	40	46	22	66	44
140	A	3	30	35	22	66	44
142	B	3	22	60	71	66	30
144	A	3	40	48	22	66	44
145	A	3	48	58	22	66	30
146	B	3	22	60	73	66	30
148	A	3	30	37	22	66	44
150	A	3	40	50	22	66	44
160	A	3	24	32	22	66	44
170	A	3	24	34	22	66	44
180	A	3	30	45	22	66	44
190	A	3	24	38	22	66	44
200	A	3	24	40	22	66	44
210	A	3	24	42	22	66	44
220	A	3	30	55	22	66	44
230	A	3	24	46	22	66	44
240	A	3	30	60	22	66	40
250	A	3	24	50	22	66	44

METRIC THREADS

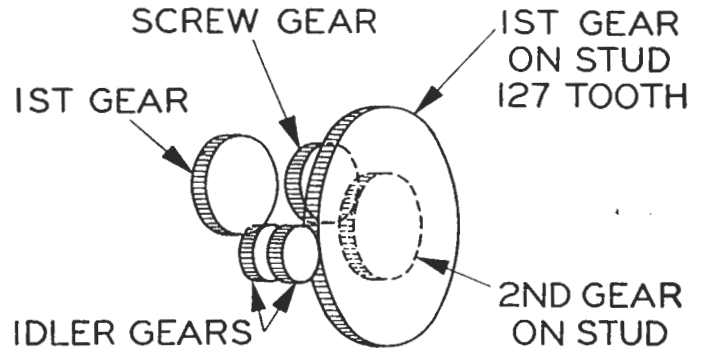

PITCH IN MM	NOB	FIRST GEAR	SECOND GEAR ON STUD	IDLER GEARS	SCREW GEAR
.1	3	25	40	50	50
.2	2	25	40	50	50
.25	2	25	50	40	50
.30	2	25	60	40	50
.35	3	50	70	30	50
.40	1	25	40	50	50
.45	3	50	54	30	30
.50*	3	50	60	30	30
.55	1	25	55	40	50
.60	1	25	60	40	50
.65	2	50	65	30	50
.70	2	50	70	30	50
.75	3	50	66	30	22
.80	2	50	56	30	35
.85	2	50	68	50	40
.90	2	50	54	30	30
.95	2	50	76	30	40
1.00*	2	50	60	30	30
1.10	1	50	55	30	50
1.20	1	50	60	30	50
1.25	2	50	60	30	24
1.30	1	50	65	30	50
1.40	1	50	70	30	50
1.50	2	50	66	30	22
1.60	1	50	56	30	35
1.70	1	50	68	30	40
1.75	2	50	77	30	22
1.80	1	50	54	30	30
1.90	1	50	76	30	40
2.00*	1	50	60	30	30
2.25	1	60	60	30	32
2.50	1	50	60	30	24
2.75	1	50	66	30	24
3.00	1	50	66	55	22

* Pitches that can be cut with standard gears supplied with machine and metric attachment.

A 127 tooth, a 50 tooth and two 30 tooth gears are supplied with metric attachment.

Tooling Dimensions

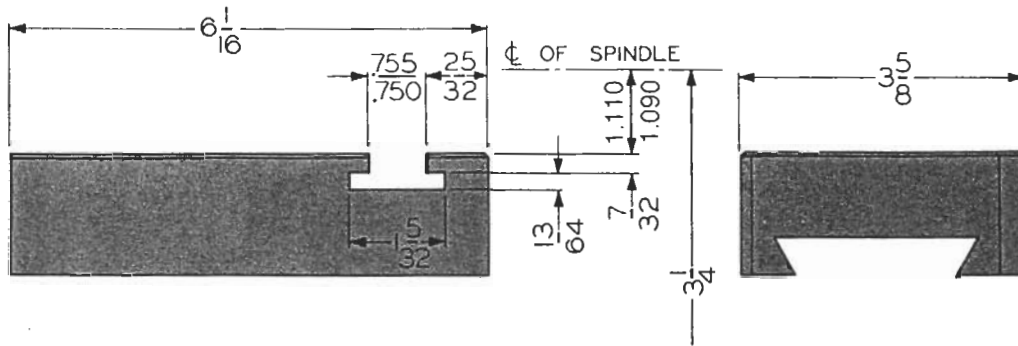

Compound Slide

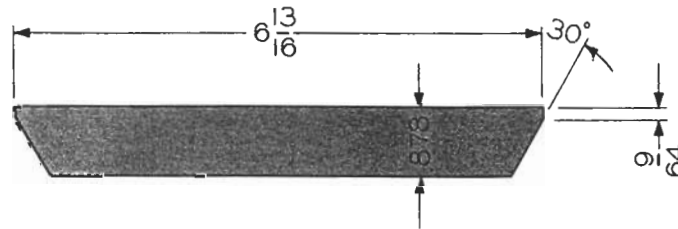

Bed Plate

Machine Floor Plan

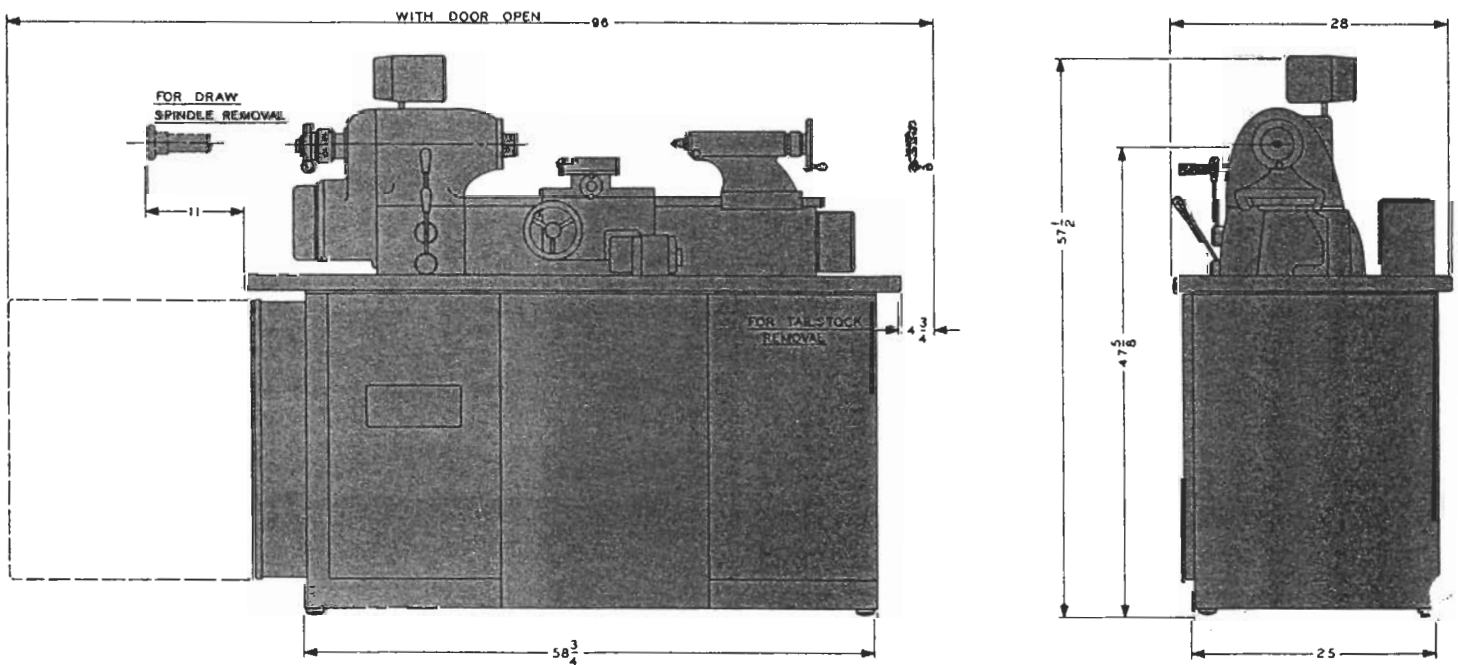

Super-Precision® Fast-Change Tool Holder

The new Hardinge fast-change tool method offers interchangeable tool holders to speed production and add versatility to the tool room.

Tool holders are changed simply by unlocking handle, changing holder and relocking handle.

Each tool holder has a simple screw adjustment for setting cutting tool to centerline of machine spindle. This eliminates the need for shims.

The fast-change base incorporates two dovetails and two mounting holes for setup convenience. A protecting cover is supplied for dovetail which is not in use.

The single and multiple tool holders take standard $\frac{3}{8}$ " square tool bits. The boring tool holder mounts $\frac{5}{8}$ " round shank boring or turning tools or standard Hardinge bushings. The knurling tools are supplied with "cutting" knurls for straight or diamond knurling from $\frac{1}{4}$ " to 6" diameters. The cut-off holder includes $\frac{1}{16}$ " wide blade.

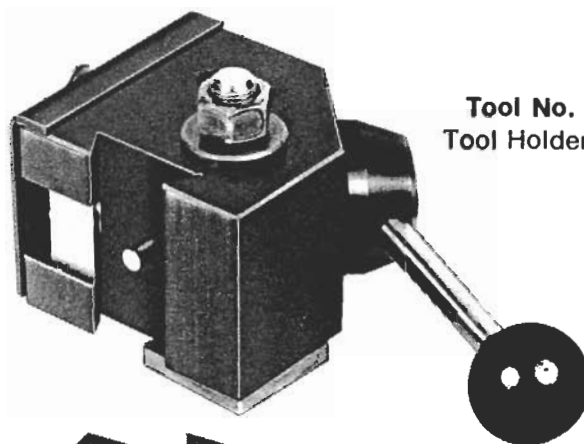

Tool No. L-18
Tool Holder Base

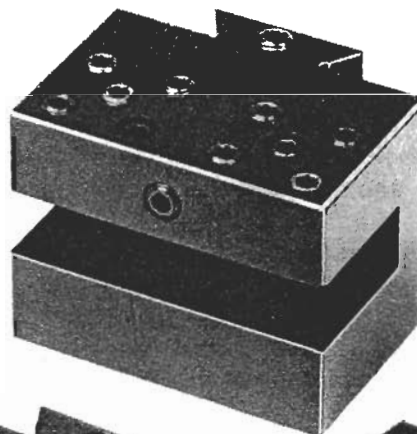

Tool No. L-22
Multiple Tool Holder

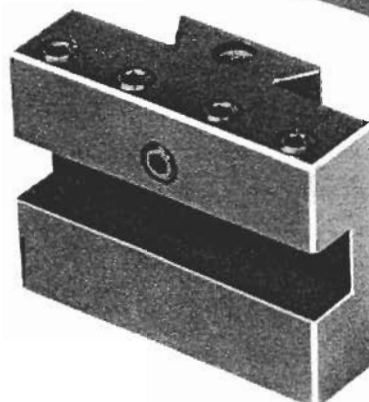

Tool No. L-21
Single Tool Holder

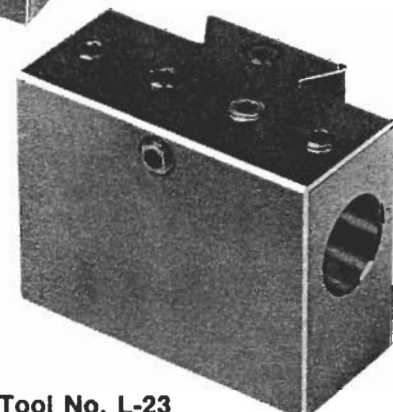

Tool No. L-23
Round Shank Tool Holder

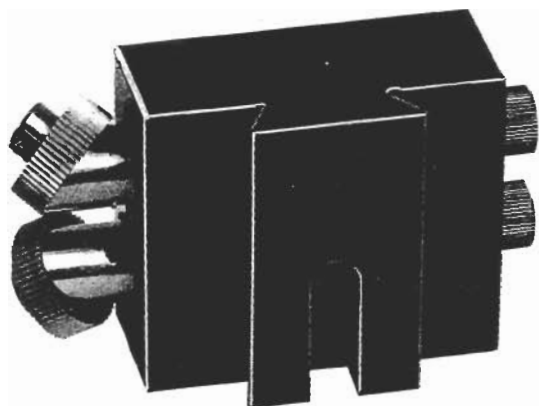

Tool No. L-20
Diamond Knurling Holder
(with two knurls)

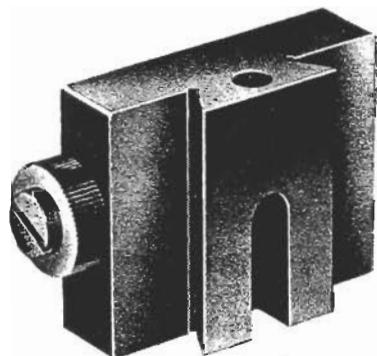

Tool No. L-24
Straight Knurling Holder
(with one knurl)

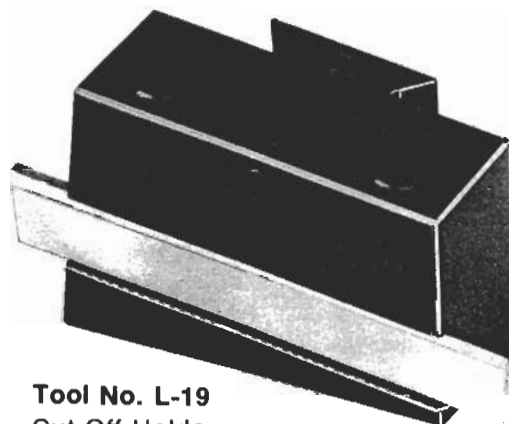

Tool No. L-19
Cut-Off Holder
(with $\frac{1}{16}$ " wide blade)

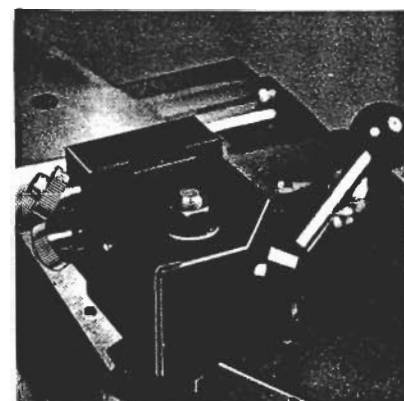

Fast-Change Tool
Base With Knurling Holder
In Place

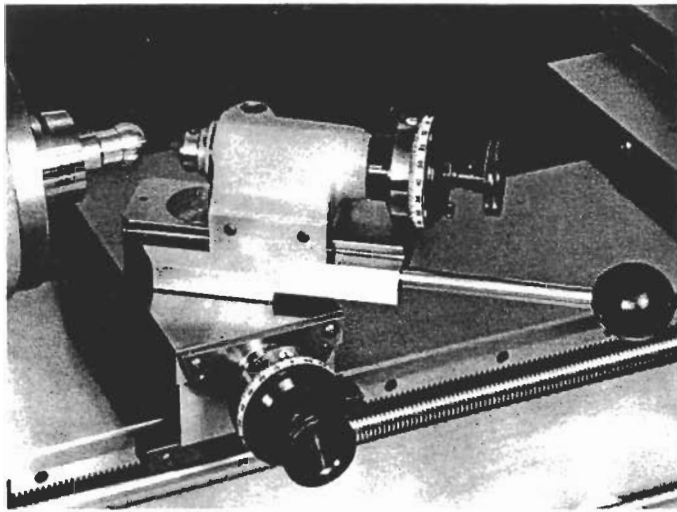

Radius Turning Attachment

For precision turning of concave or convex surfaces up to 1½" radius. Useful for turning punches, dies, ball shaped valve seats and special spherical cutting tools.

The swivel slide is mounted on precision preloaded ball bearings for accuracy and rigidity. The swivel slide moves through 360°. Hardened feed screws are mounted on preloaded ball bearings and have adjustable dials graduated in thousandths of an inch.

Tool No. L-9

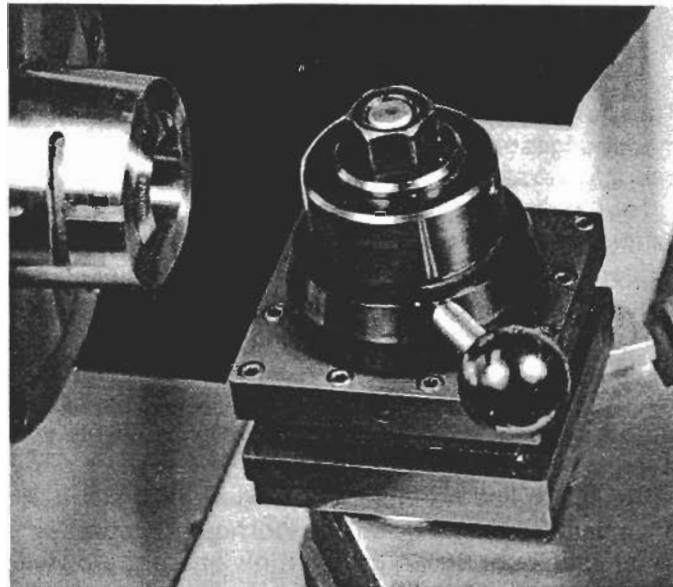

Automatic Indexing Turret

The square turret is applied directly to the tool post T-slot of the compound slide. The turret takes standard ⅜" square tool bits. By a simple movement of the ball-handled lever, the turret is automatically unlocked, indexed to the next tool position and relocked, ready for the next machining operation.

Tool No. HTL

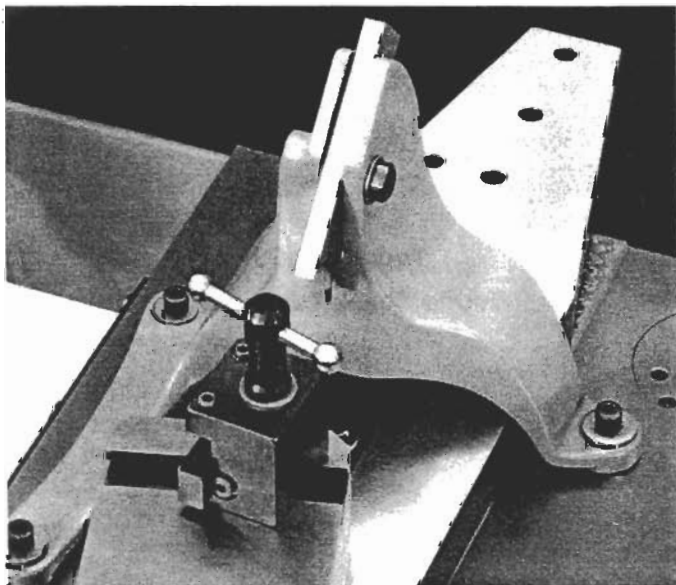

Follow Rest

When you have work that is small in diameter in relation to length it may spring away from the cutting tool. In such cases, the follow rest applied to the carriage, as shown, will assure you of accurate work. See Page 12 for mounting instructions.

Tool No. L-12

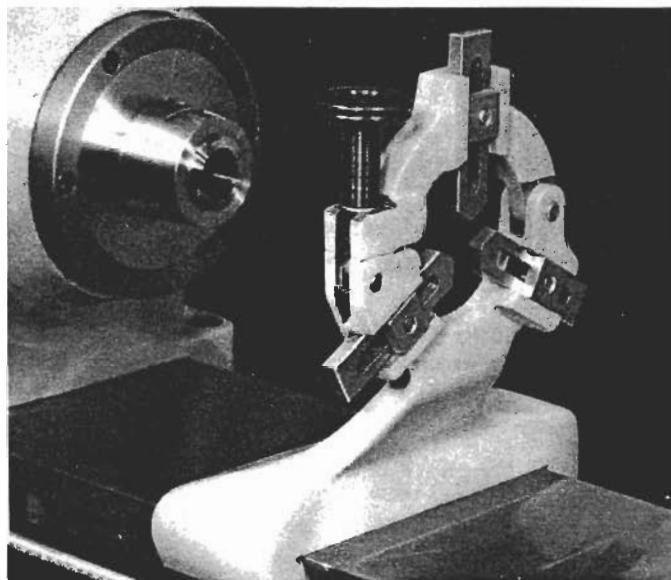

Steady Rest

Long cylindrical work held between centers requires a steady rest to prevent such work from springing away from a cutting tool. A steady rest is also used when there are machining operations to be performed on the end of work which prohibits the use of the tailstock center. The steady rest has a maximum capacity of 3".

Tool No. L-11

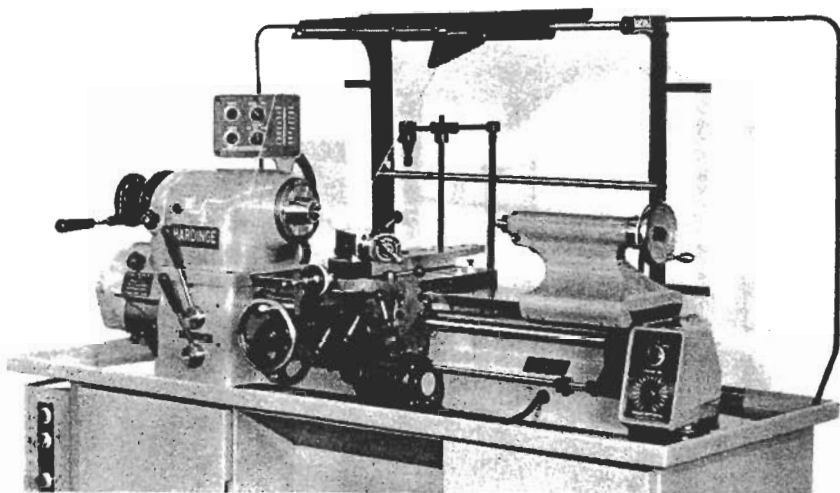

Chip and Coolant Shield

This transparent plastic chip and coolant shield is available for use with the Hardinge HLV-H lathe. The hinged section is adjustable to left or right to suit work requirements.

New extended sections offer additional splash protection.

We recommend the chip and coolant shield be included with all Hardinge lathes.

Tool No. L-14

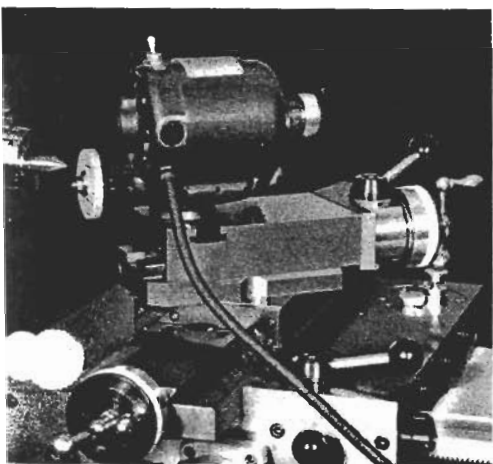

Motor Grinder

The motor grinder unit mounts directly to the compound slide T-slot. It can be used for both external and internal grinding. Motor operates on 110 volt, single phase current. See Page 12 for instructions.

Tool No. L-7



Adjustable Height Chair

Provide your operators with a proper chair having both an adjustable height seat and back rest . . . better work will result.

Tool No. L-15

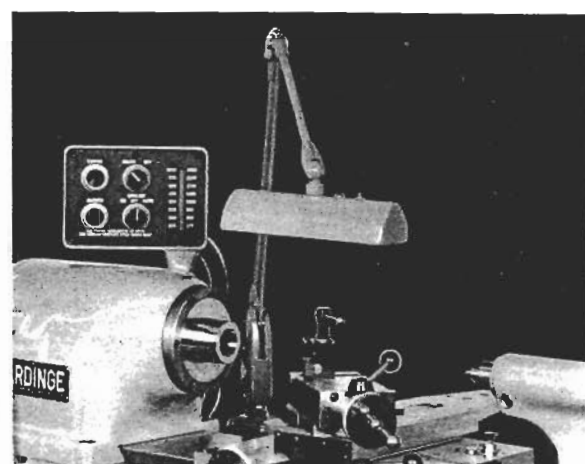

Machine Lamp

This fluorescent lamp is available for use with the Hardinge HLV-H lathe. The lamp fastens to the back of the lathe bed and operates from the regular 110 volt light line.

Tool No. L-13

Taper Turning Attachment

The turning or boring of precision tapers is readily accomplished on the Hardinge HLV-H lathe by the use of a taper turning attachment. The Hardinge taper turning attachment is based on the sine bar principle — swiveling the guide bar from one end. Graduations for setting guide bar are in $\frac{1}{8}$ " taper per foot and in degrees.

The taper turning attachment mounts directly on the back of the lathe bed and is adjustable along the bed to suit the work. See page 12 for instructions.

Tool No. L-8

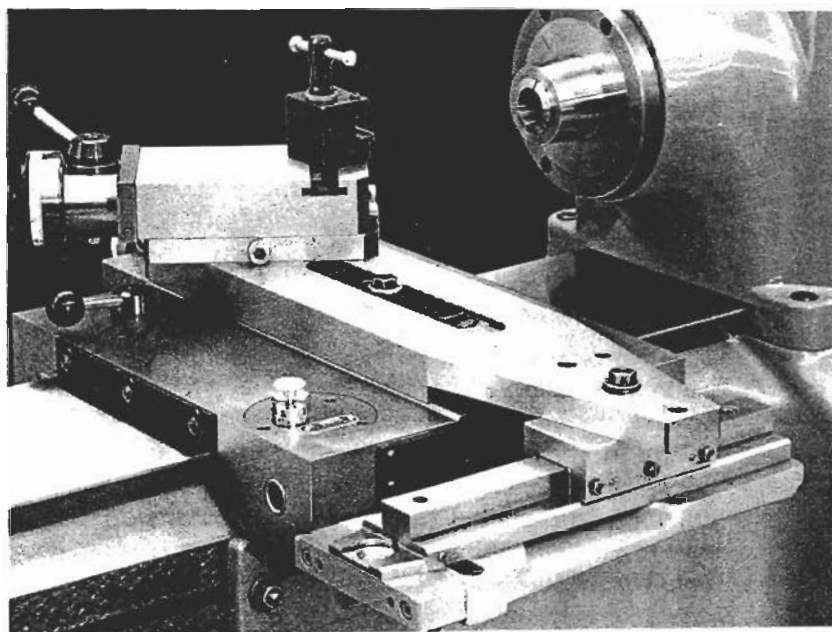

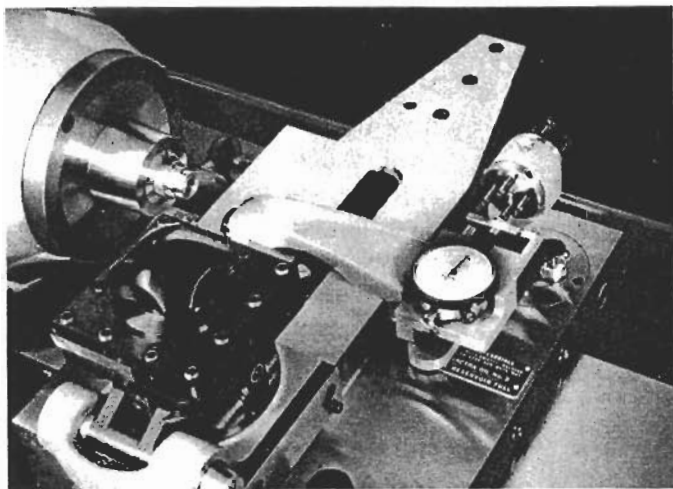

Four Position Indicator Stop for Cross Slide

The Hardinge Four Position Indicator Stop is quickly and easily mounted on the cross slide and carriage of HLV-H Tool Room Lathe. The unit has a four station easily revolved stop drum with adjustable reference screws. The indicator is a .0001" jeweled bearing type with a built-in feature protecting the indicator against over-travel.

Tool No. HLV H-CS

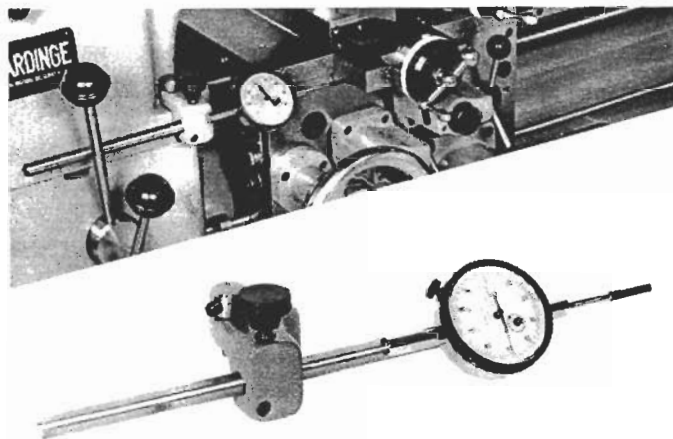

Carriage Length Indicator

The Hardinge carriage length indicator permits full carriage travel, thus allowing for "close to spindle machining".

The carriage length indicator is a needed accessory when producing parts to exact shoulder lengths or when facing to close tolerances.

The fully jeweled dial indicator reads directly in .001" increments with a range of 1". The long rod allows the indicator to be extended to a distance of 6½".

The carriage length indicator can be mounted on your HLV-H Lathe without machining.

Tool No. HLV H-HD1

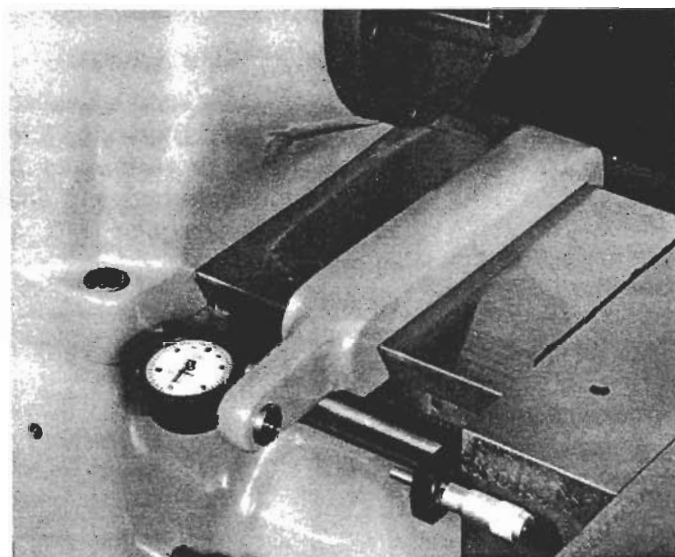

Indicator Carriage Stop

The micrometer carriage stop is a useful accessory when producing parts with exact shoulder lengths or when facing to close tolerances.

The indicator reads in .0005" increments. The micrometer reads in .001". Each HLV-H lathe is machined for direct application of the indicator stop. See Page 12 for mounting instructions.

Tool No. HLV H - BD1

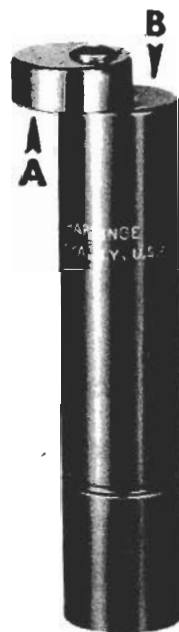

Tool Setting Gage

The Hardinge tool setting gage is an essential aid for fast, accurate setting of tool bits and boring bars to the spindle centerline of your Hardinge HLV-H Tool Room Lathe.

The ground surface "A" is for setting tools cutting on front of work piece. Surface "B" is used for setting tools cutting on rear of work piece. The gage is adjustable for its respective machine.

Tool No. L-2



HARDINGE BROTHERS, INC., ELMIRA, N.Y. 14902
"PERFORMANCE HAS ESTABLISHED LEADERSHIP FOR HARDINGE"®

M-2E
Part No. M E-0009500-0002
January 1989

Litho in U.S.A.